

# CORDLESS FABRIC ROMAN SHADE INSTALLATION INSTRUCTIONS

## 1. PACKAGE CONTENTS

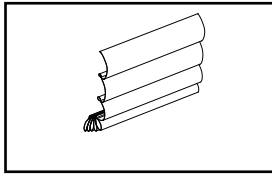

Shade

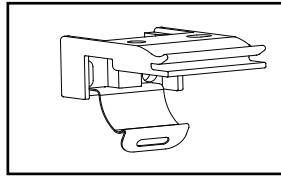

Mounting  
Brackets

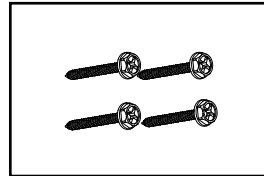

1-1/4 inch  
Screws & Anchors

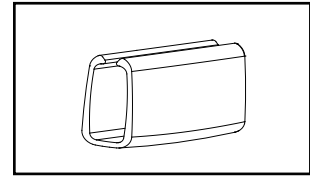

Handle

Shade Width	Mounting Brackets Quantity	Handle Quantity
Up to 48 inch	2	1
Up to 60 inch	3	2
Up to 72 inch	4	2

## 2. TOOLS YOU MAY NEED

Screwdriver

Pencil

Drill/drill bits

Measuring Tape

## 3. DETERMINE INSIDE/CEILING, FLUSH, WALL OR OUTSIDE MOUNT

### a. Inside, Ceiling or Flush Mounts

(A minimum 1 inch depth is required or 1-3/4 inch depth for flush mounts.)

1. Test the location for the end mounting bracket 1 to 6 inches from the end of each headrail side. Position each mounting brackets so that there is no interference with the cords and mechanisms inside the headrail.
2. For wider shades that require 3 or 4 brackets, position the mounting brackets so that they are spaced evenly between the two outermost mounting brackets.
3. Mark the mounting bracket locations upward through the holes with a pencil (ensure that the position of the mounting bracket's release tab is facing downward).
4. Use the 1-1/4 inch screws to anchor in the (pencil marked) top bracket holes to firmly attach the mounting brackets to the surface.

### a. INSIDE OR CEILING MOUNTS

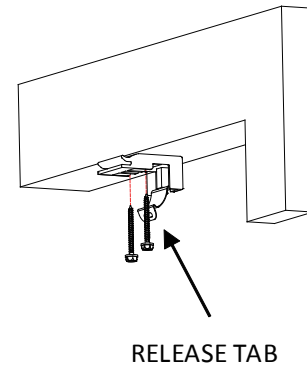

### b. Wall or Outside Mounts

(A minimum 1-1/2 inch flat wall space is necessary.)

1. Test the location for the end mounting bracket 1 to 6 inches from the end of each headrail side. Position each mounting brackets so that there is no interference with the cords and mechanisms inside the headrail.
2. For wider shades that require 3 or 4 brackets, position the mounting brackets so that they are spaced evenly between the two outermost mounting brackets.
3. Mark the mounting bracket locations towards the back, rear holes with a pencil (ensure that the position of the mounting bracket's release tab is facing downward).
4. Use the 1-1/4 inch screws to anchor in the (pencil marked) rear bracket holes to firmly attach the mounting brackets to the surface.

### b. WALL OR OUTSIDE MOUNTS

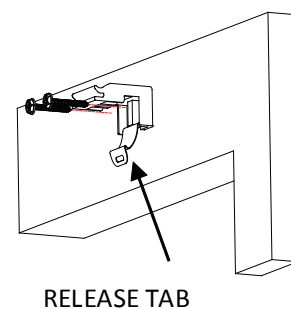

## 4. INSERTING THE HEADRAIL

---

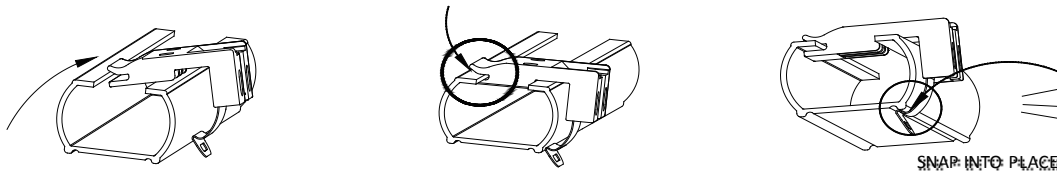

- Lift the headrail into position so that the front edge of each mounting bracket is under the inner front edge of the headrail
- Rotate the headrail back towards the window, then push the headrail upward until the flexible tab at the bottom of each bracket snaps onto the back of the headrail. Once a snapping sound is heard, you will know the headrail is attached to the mounting bracket.
- Check to assure that each mounting bracket is properly secured to the headrail.

## 5. ATTACH THE HANDLE / HOW TO OPERATE

---

Attach the handle to the bottom of the shade as illustrated below. For shades over 48 inch wide, attach two handles, shoulder width apart at the center. The handle is designed to minimize contact with the fabric of the shade. Always raise and lower the shade slowly to assure that the fabric gathers neatly.

To lower the shade: grip the handle and slowly pull straight down.

To raise the shade: put one hand under the handle (palm facing up) and lift slowly until the desired height is reached.

Important Note: Always push and pull at the center of the shade to assure that the bottom of the shade remains even (i.e. parallel to the top of the shade). If the shade becomes uneven, slowly pull it all the way down, and then lift up to the desired position. If necessary, reach behind the shade and manually pull the cording slowly out of the headrail until the bottom of the shade is level.

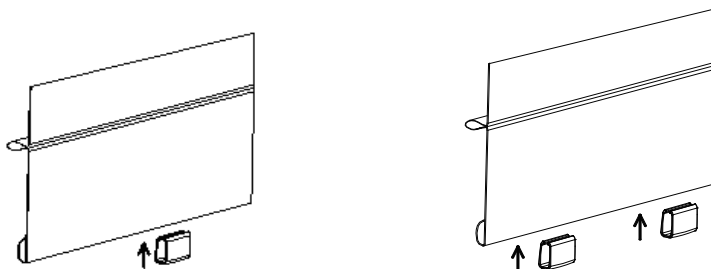

## 6. REMOVE THE HEADRAIL

---

- To remove the blind, insert a screwdriver between the headrail and the bottom back of the mounting bracket (tab which extends out slightly from each mounting bracket).
- Gently pry the screwdriver to release the mounting bracket from the headrail. Please be cautious to not damage the painted finish of the headrail. As you release the mounting brackets, support the headrail.

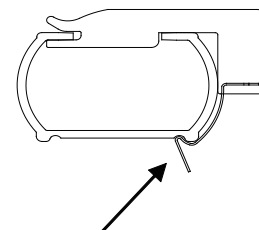

Insert screwdriver here and gently pry to release.

## 7. CLEANING & CARE

---

Packaging and shipping will typically cause the fabric of this product to wrinkle. First, allow all items to hang for a few days so that the wrinkles can relax and begin to fall out. If necessary, steam the shade on a low heat setting to remove stubborn wrinkles. However, be aware that if the temperature is too high, it could melt/damage the shade. To clean the fabric on the shade, use a feather duster or vacuum lightly using the soft brush attachment.