

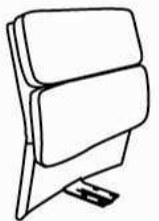







Please unscrew mechanism and L-bar hardware from cushion before assembly.

Por favor de destornillar todos los tornillos del cojín antes de ensamblar la silla.

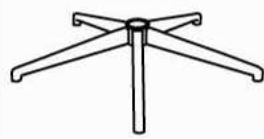
MODEL: B9406

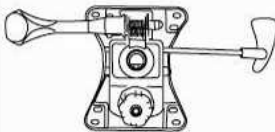
(1)X1 	(2)X1 	(3)X1 (L)x1 (R) 
(4)X1 	(5)X1 	(6)X5 
(7)X1 	(8)X1 	

Please unscrew all screws from the bottom of seat cushion before assembly.

- (A)X4  M8*45 ARM SCREW
- (B)X4  M8*25 L-BAR SCREW
- (C)X4  M8*22 MECHANISM SCREW
- (D)X4  ARM CAP

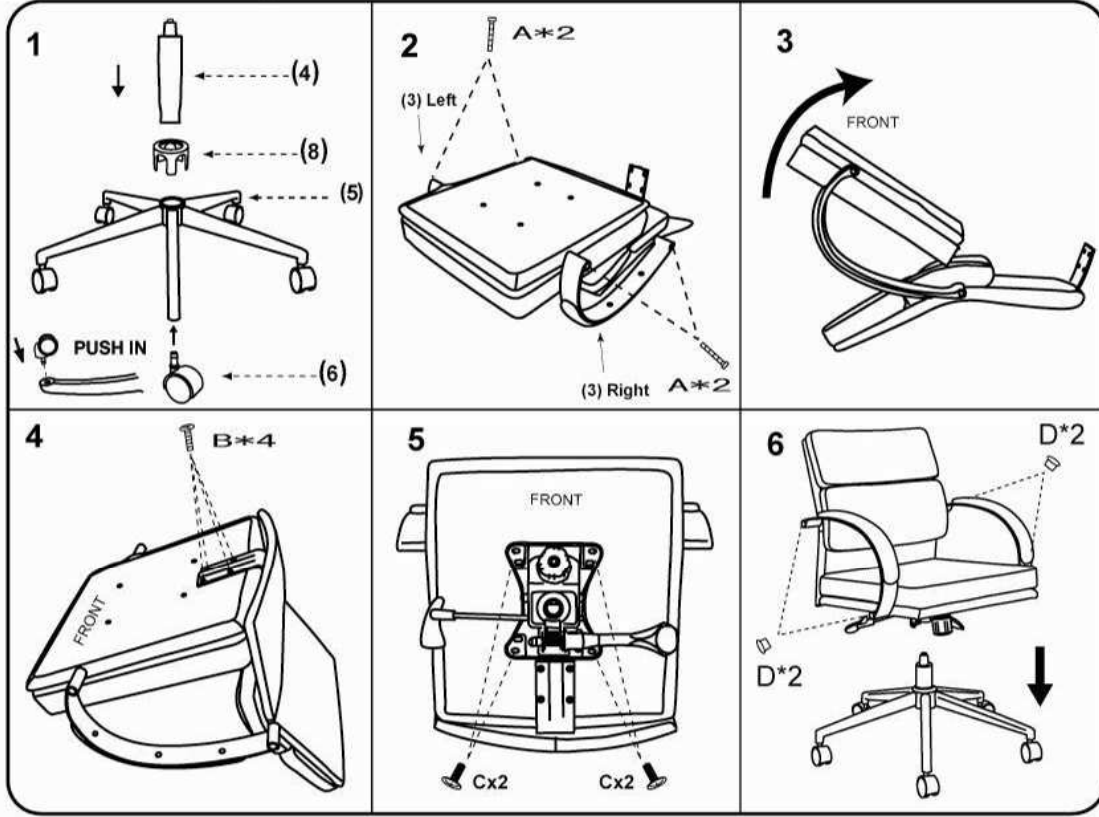

Step 3: Do NOT tighten arm screws.
Step 7: Tighten arm screws before you put on the arm caps.

Insert and loosely tighten all screws. When assembly is completed, fully tighten all screws before using. This chair is only intended for sitting. Any other use will void the warranty.

