

Tools Required: Flathead screwdriver, Phillips screwdriver, pliers, wire cutters, wire strippers, electrical tape, safety glasses.

Bulb Recommended: (3) Medium Base 100W Maximum, Alternate bulb (3) 23W CFL

Estimated Assembly Time: 30-45 minutes

Preparation: Identify and inspect all parts before beginning installation. Check package content list and diagrams below to be sure all parts are present. If any parts are missing or damaged, do not attempt to assemble, install, or operate the fixture. Contact customer service for replacement parts.

⚠ Warnings and Cautions

Turn off electricity at circuit breaker or main fuse box before installation. Consult a licensed electrician if in doubt.

These instructions are provided for your safety. It is very important you read them completely before installing the fixture. We strongly recommend that a licensed, professional electrician perform the installation.

Disconnect fixture from power source before replacing bulbs. Make sure bulbs are given sufficient time to cool before removal. Do not subject glass parts to any shock while in operation or shattering may result.

⚠ Care of Tiffany Style Shade

A new tiffany lamp shade has an oil film applied to the shade that protects the tiffany shade from scratches during shipment. If the oil applied is too heavy you can remove the excess oil film with a paper towel. Gently wipe away the excess oil.

For general cleaning of tiffany shades use a gentle lemon oil-based furniture polish applied to a soft cloth and wipe gently.

If a white powder appears on the soldered joints of the tiffany shade this is a normal oxidation process. Use a small amount of lemon oil or mineral oil applied directly to oxidized areas and the soldered area will return to like new.

Package Contents

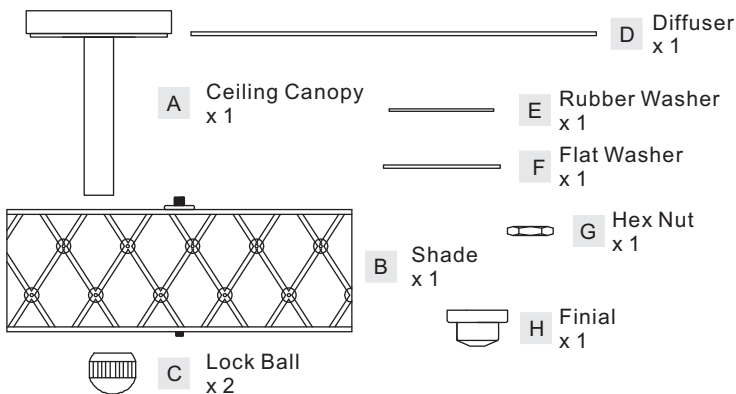

Hardware Contents

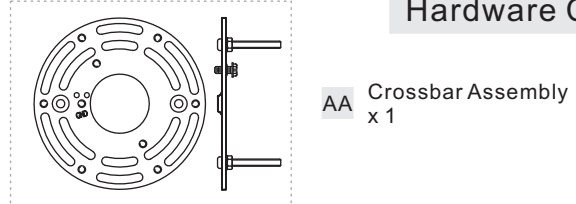

STEP 1 – Install Crossbar

A. Attach the Crossbar Assembly (AA) to the Outlet Box with the head of the Green Ground Screw facing you. Secure it with Outlet Box Screws (not included). Tighten until snug.

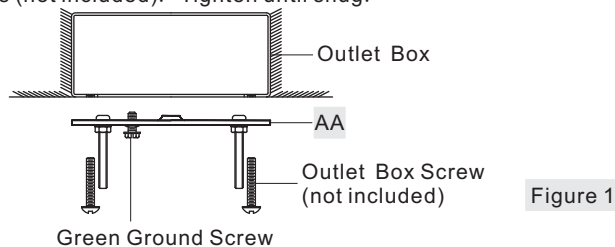

STEP 2 - Wire Connections

A. Use standard wire connectors (not included) to make all wire connections. (Connectors are not included with fixture.) Strip and prepare wire ends according to instructions supplied with connectors.

- B. Connect White Supply Wire from the Outlet Box to Ribbed side Wire from fixture.
- C. Connect Black (or Red) Supply Wire from the Outlet Box to Smooth side Wire from fixture.
- D. Connect Ground Wire from the Outlet Box to Ground Wire from fixture.
- E. Twist connectors until wires are tightly joined together.
- F. Wrap each connection with approved electrical tape and carefully stuff all the connected wires into the Outlet Box.

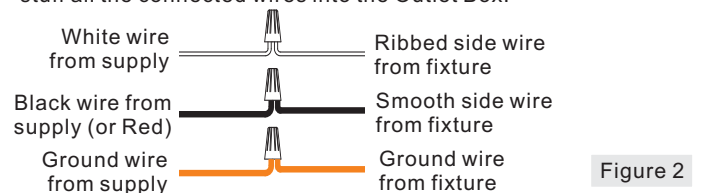

STEP 3 – Attach Shade to Ceiling Canopy

A. Thread Ceiling Canopy (A) onto the Shade (B). Hand tighten until snug.

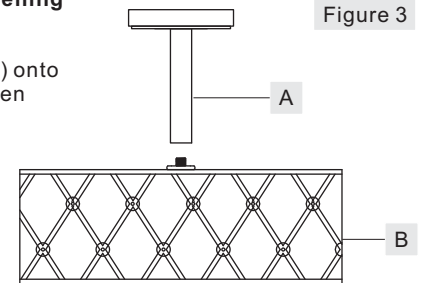

STEP 4 – Attach Fixture Body to Mounting Screw

- A. Place the Ceiling Canopy (A) over the Mounting Screws and secure with Lock Ball (C). Hand tighten until snug.

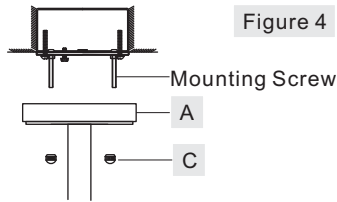

Figure 4

STEP 6 – Install Bulb

- A. This fixture uses standard bulb with medium base. Maximum 100 watts.
 B. Insert bulb and screw snugly into place.

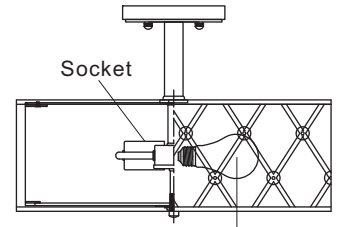

Figure 6

STEP 5 – Attach Shade to fixture

- A. Place the Diffuser (D), Rubber Washer (E) and Flat Washer (F) over the Center Stem, secure with the Hex Nut (G). Hand tighten until snug.
 B. Thread the Finial (H) onto the Center Stem, hand tighten until snug.

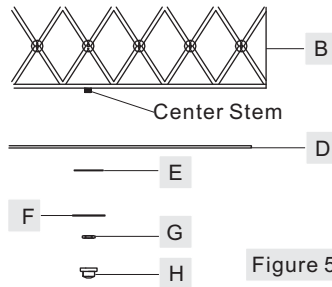
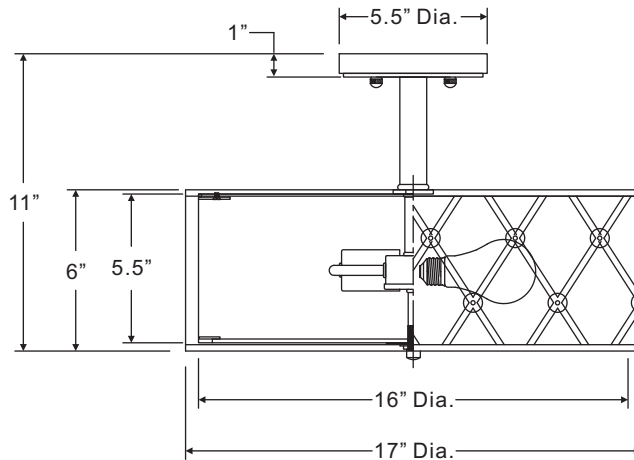
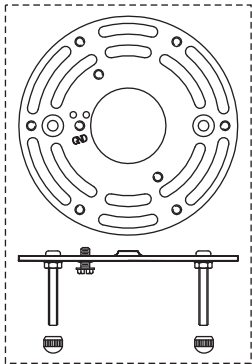

Figure 5

Your fixture is now assembled and ready to use. Enjoy!

SKU: UQL2121



(3) 100W Medium Base Bulbs (Not Supplied)

NOTE: ALL DIMENSIONS ARE ROUNDED UP TO THE NEAREST 1/2"

NO.	PART NUMBER	REPLACEMENT PART DESCRIPTION	REQ.
1			
2			

urban ambiance

www.urbanambiance.com