

ASSEMBLY INSTRUCTIONS

HYNS-001

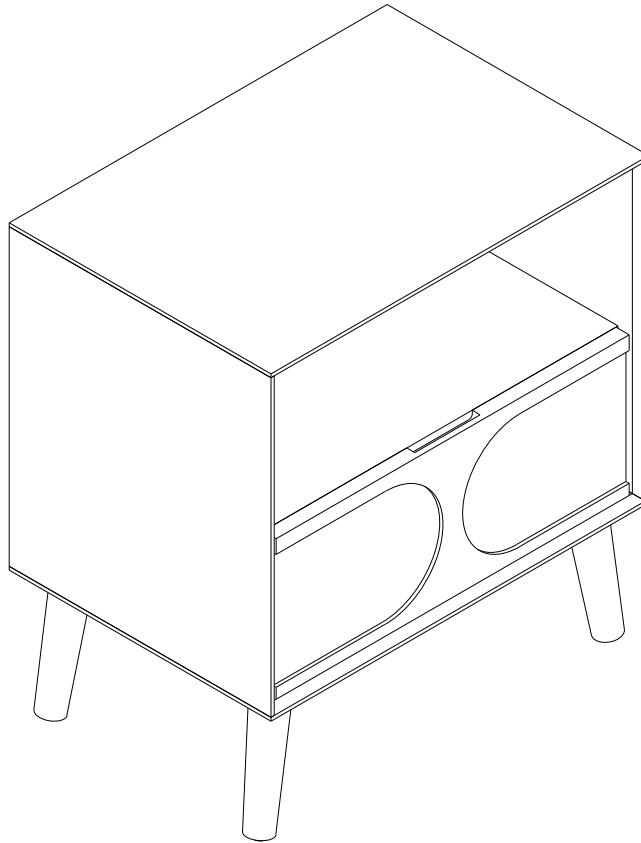

Notice:

1. Follow the installation instructions. Please confirm all accessories are preset before installation.
2. Do not fully tighten the screws during initial assembly. Fully tighten screws only once all pieces which are correctly assembled.
3. If you encounter any problems during installation, please contact our customer service.
4. Please unbox the item from the side with an open-label and put a carpet on the floor to avoid scratching it.

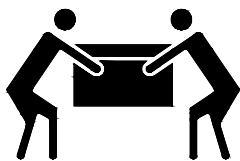

Recommended installers:2

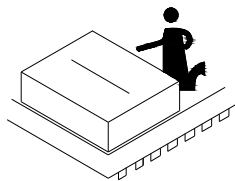

Put a carpet on the floor
before unpacking

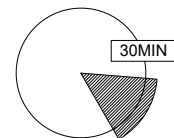

Estimate installation time:
30minutes





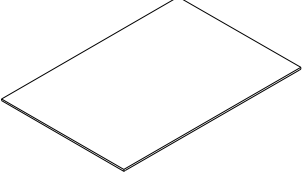
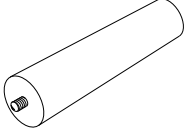
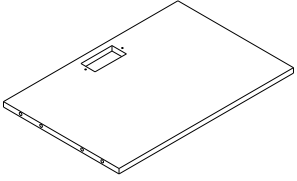
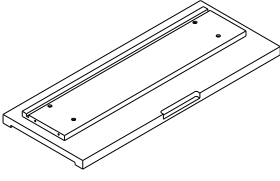
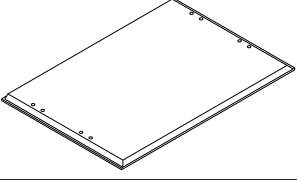
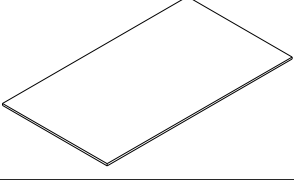
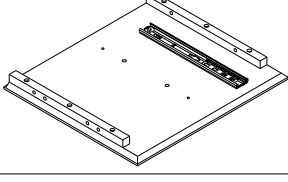
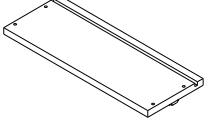
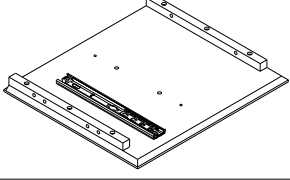
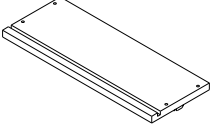
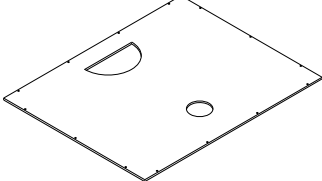
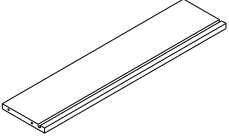

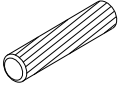
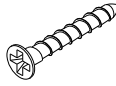

ASSEMBLY INSTRUCTIONS

PART LIST

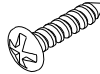
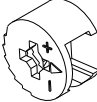
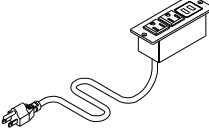
Item no.	Reference Image	Qty	Item no.	Reference Image	Qty
(A)		X1	(G)		X4
(B)		X1	(H)		X1
(C)		X1	(I)		X1
(D)		X1	(J)		X1
(E)		X1	(K)		X1
(F)		X1	(L)		X1

ASSEMBLY INSTRUCTIONS

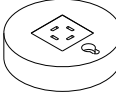
HARDWARE LIST

Item no.	Reference Image	Qty	Item no.	Reference Image	Qty
1	 Ø8*30mm	X12+1	7	 Ø3.5*30mm	X8
2		X4	8	 Ø3*15mm	X14+1
3		X4	9		X1
4	 Ø1/4"*1-1/4"	X8	10	 Ø3*15mm	X2
5		X8	11		X1
6		X8	12		X1

ASSEMBLY INSTRUCTIONS

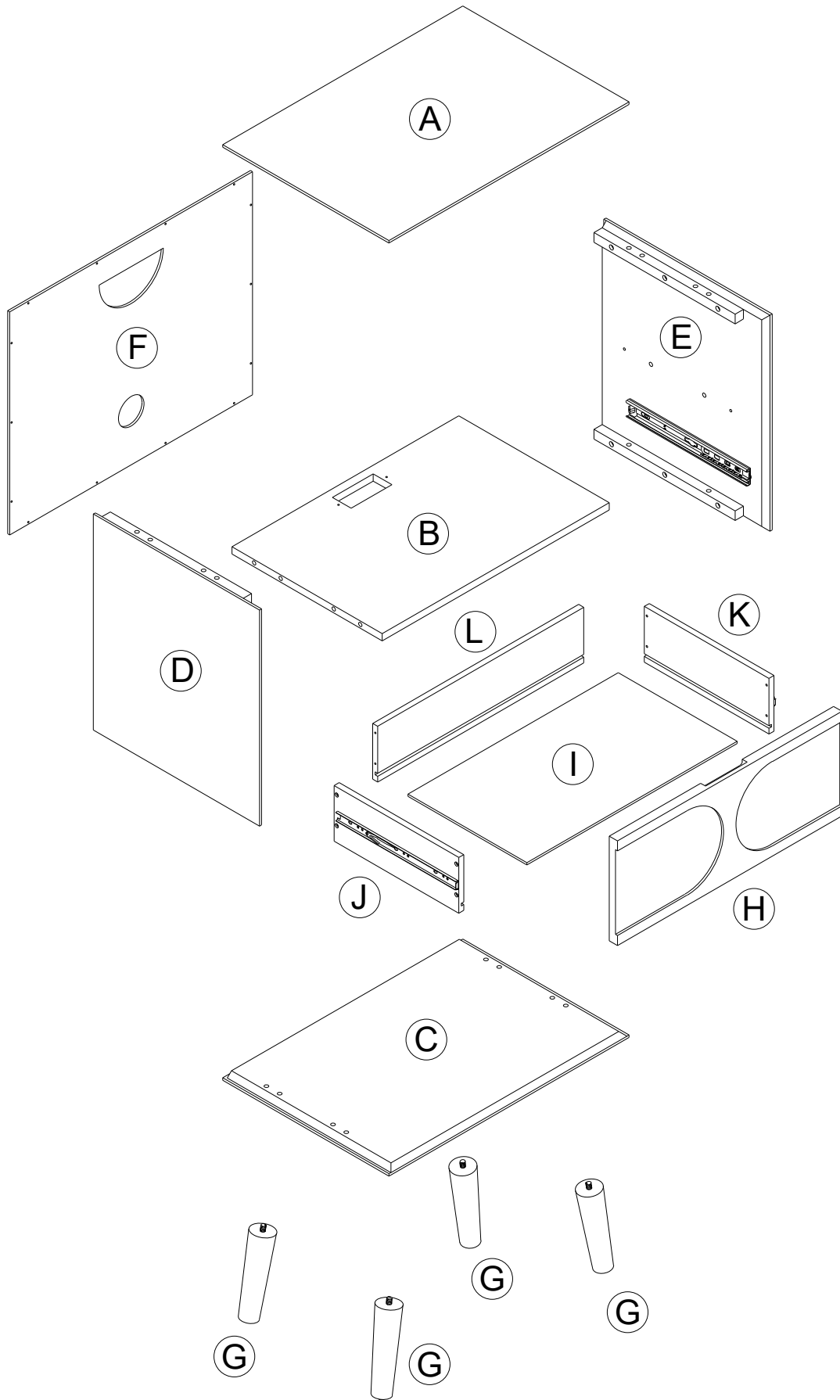

ASSEMBLY INSTRUCTIONS

1

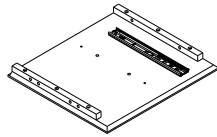

Ⓓ 1PC

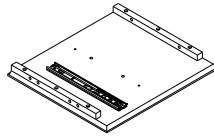

Ⓔ 1PC



Ⓐ 4PCS

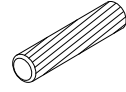

Ⓑ 4PCS

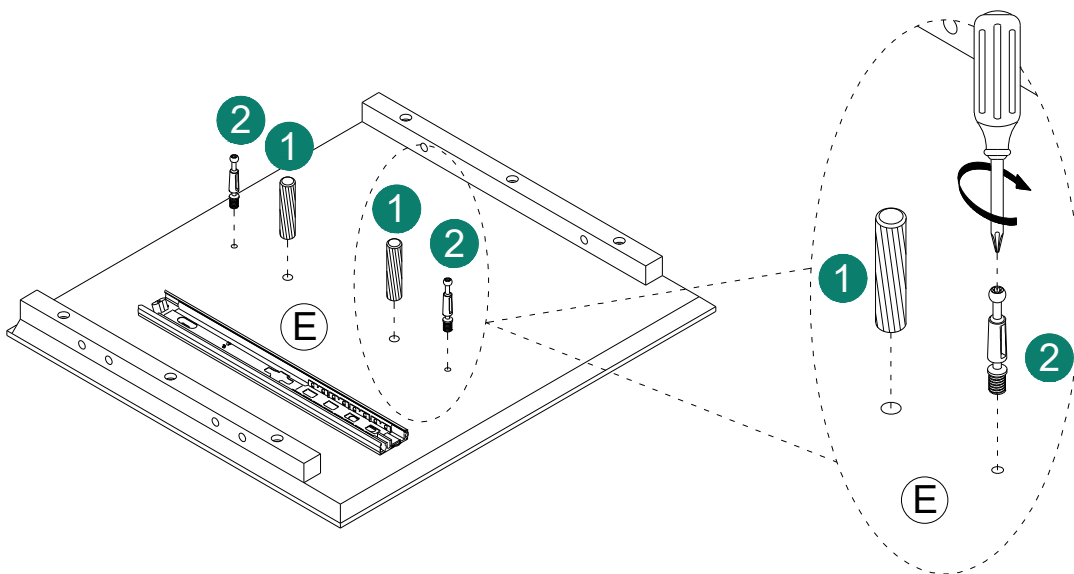
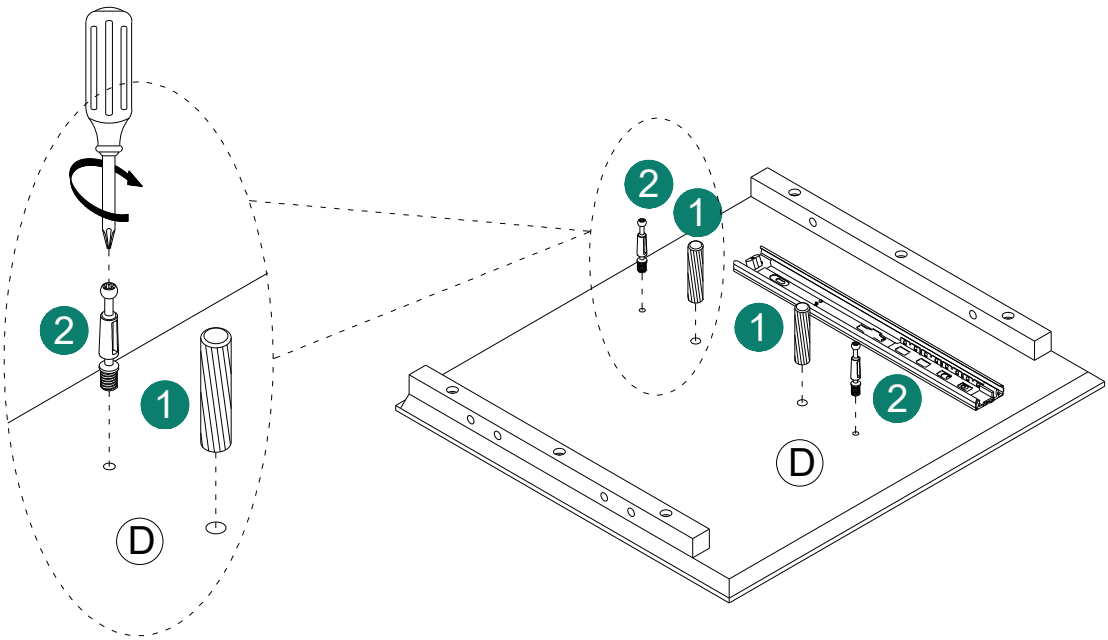

ASSEMBLY INSTRUCTIONS

2

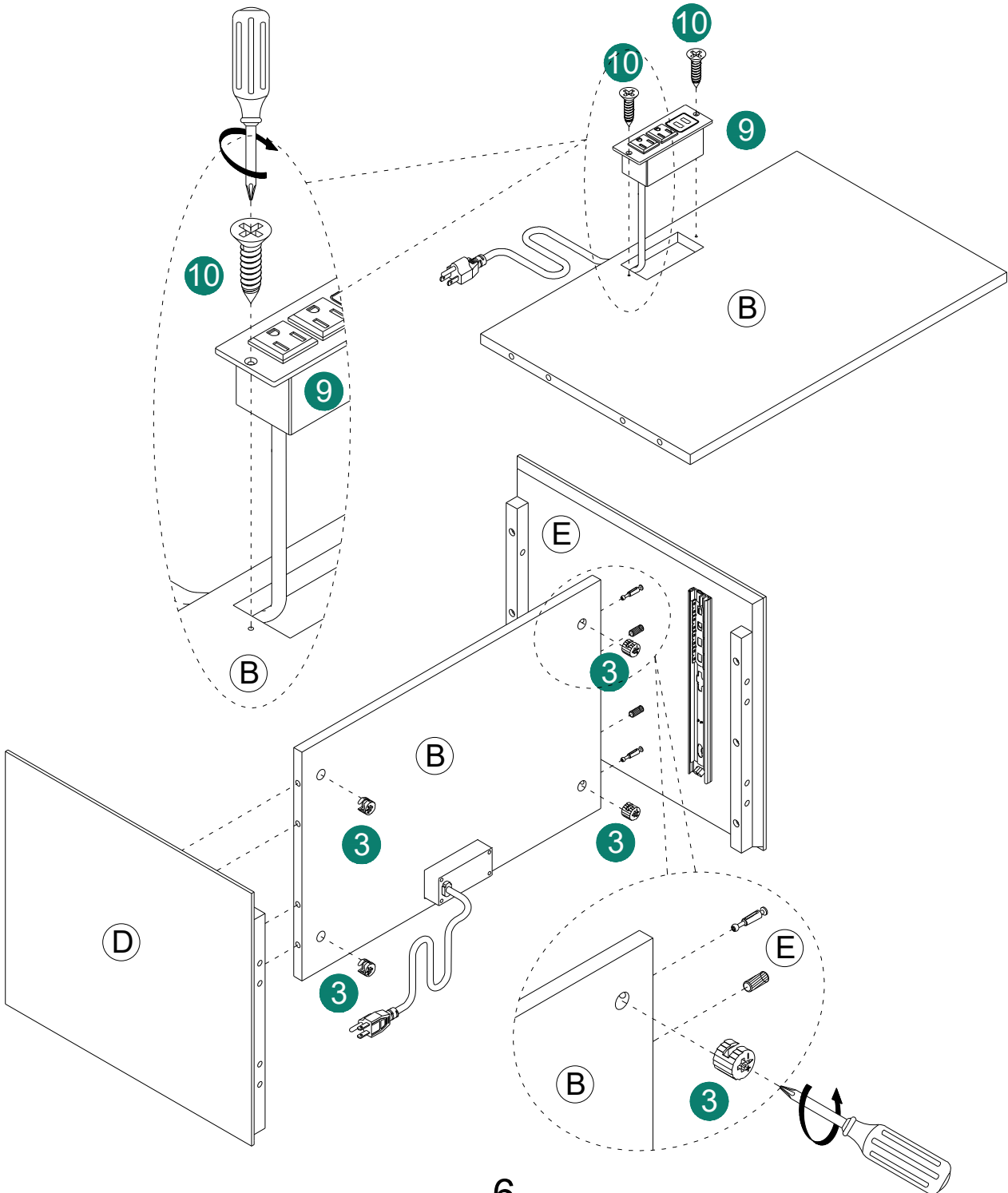
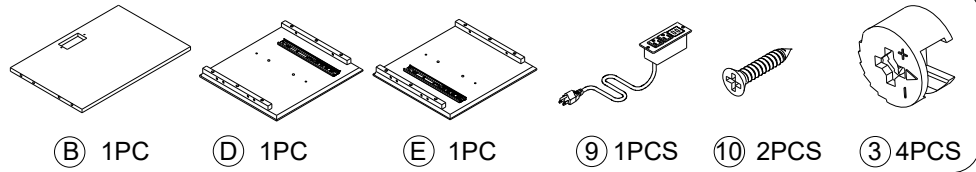

6

ASSEMBLY INSTRUCTIONS

3

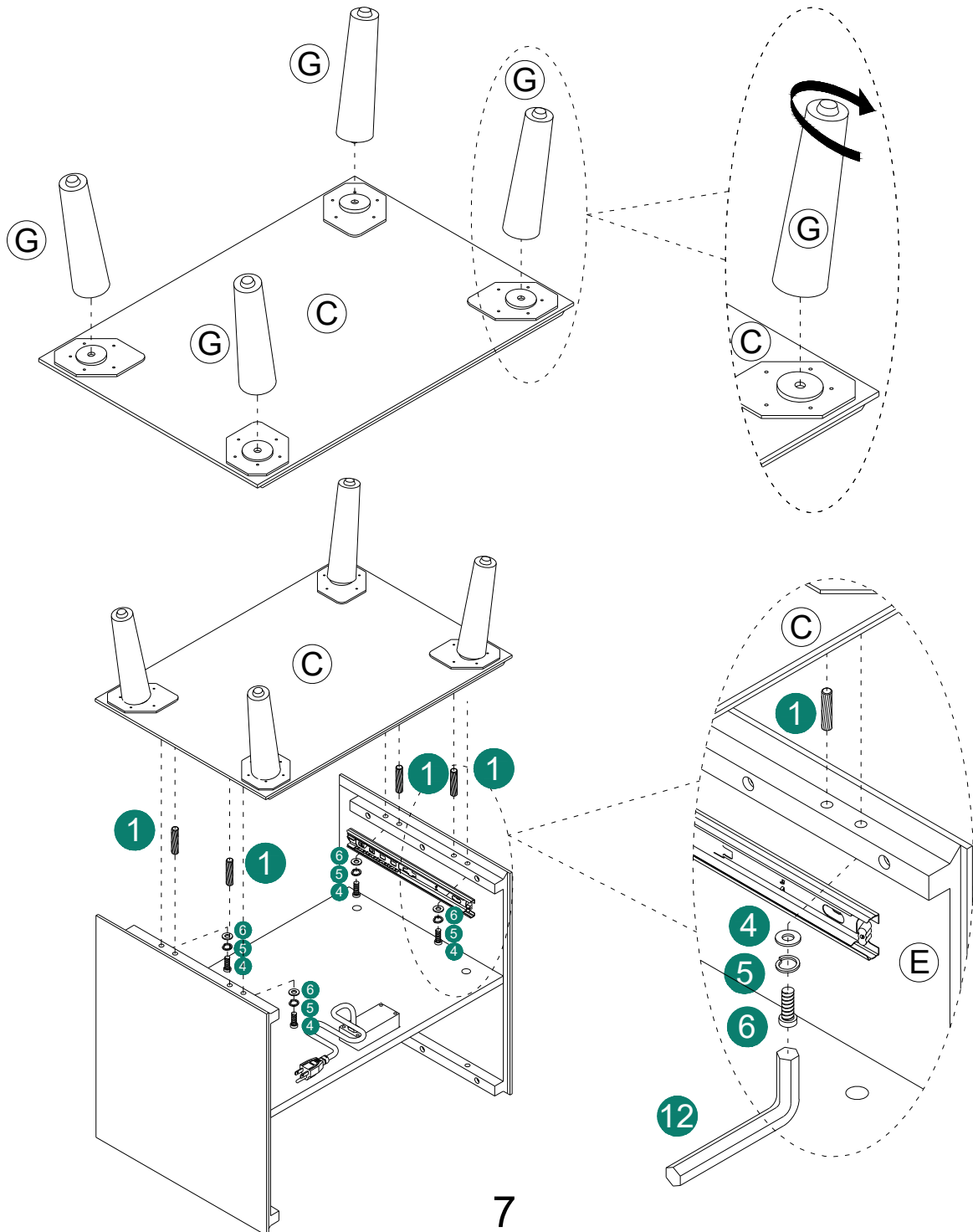
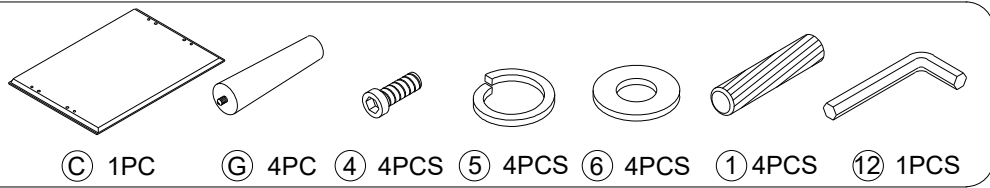

ASSEMBLY INSTRUCTIONS

4

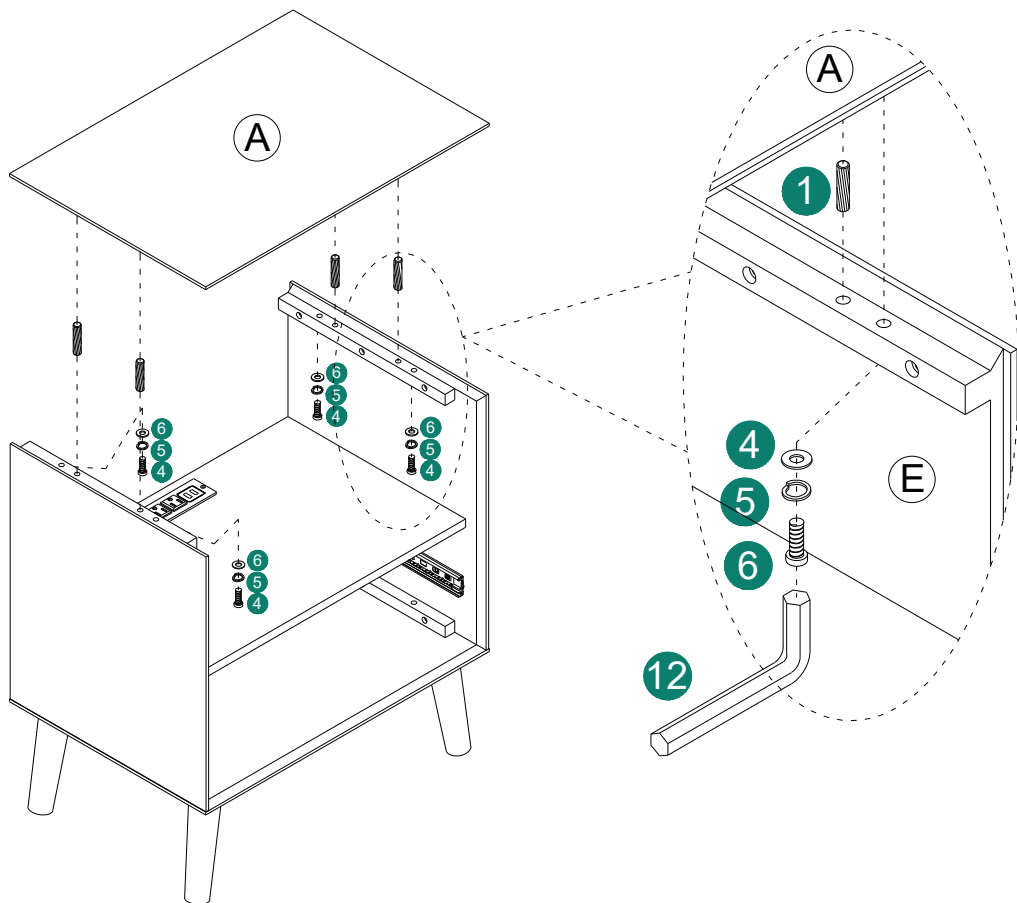
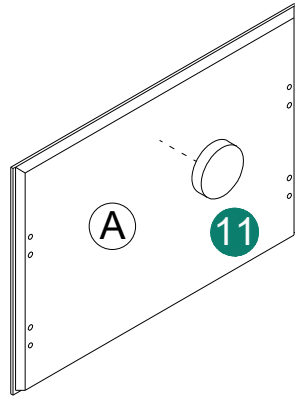
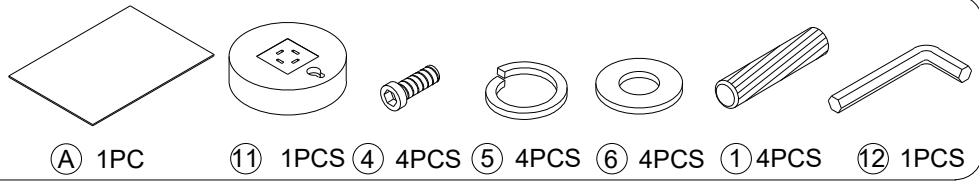

ASSEMBLY INSTRUCTIONS

5

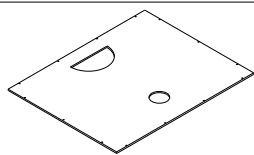

(F) 1PC

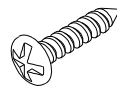

(5) 14PCS

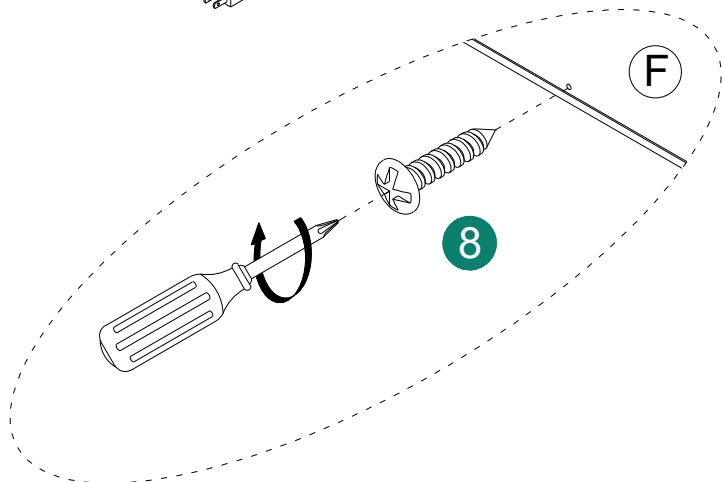
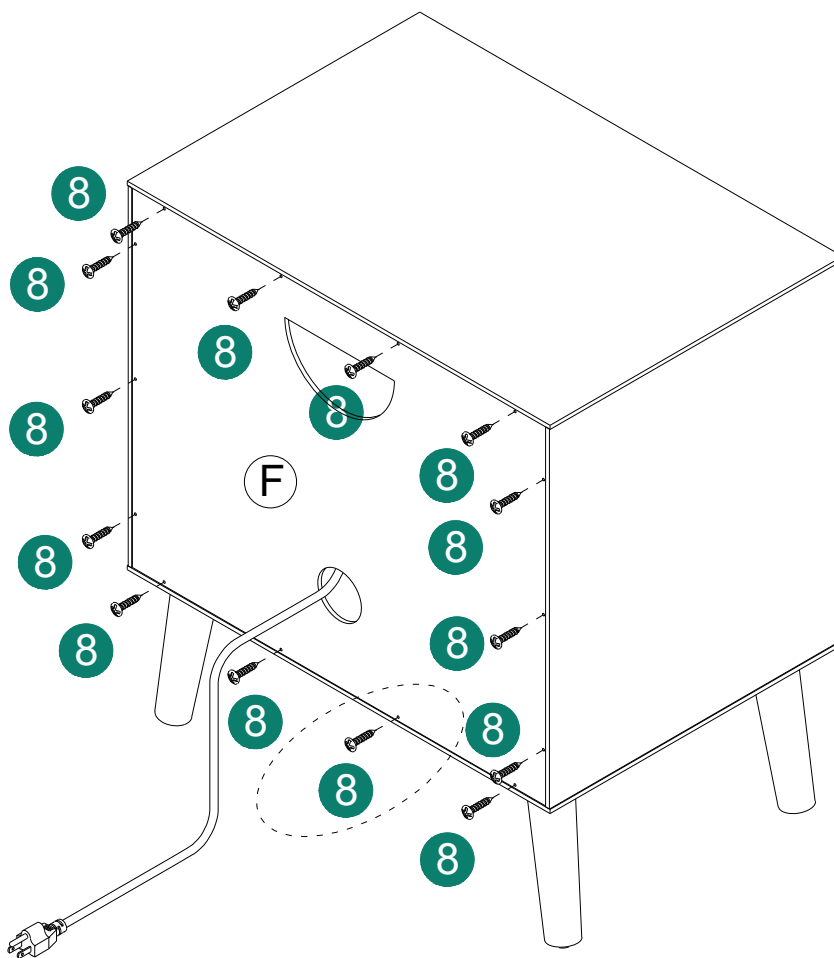

ASSEMBLY INSTRUCTIONS

6

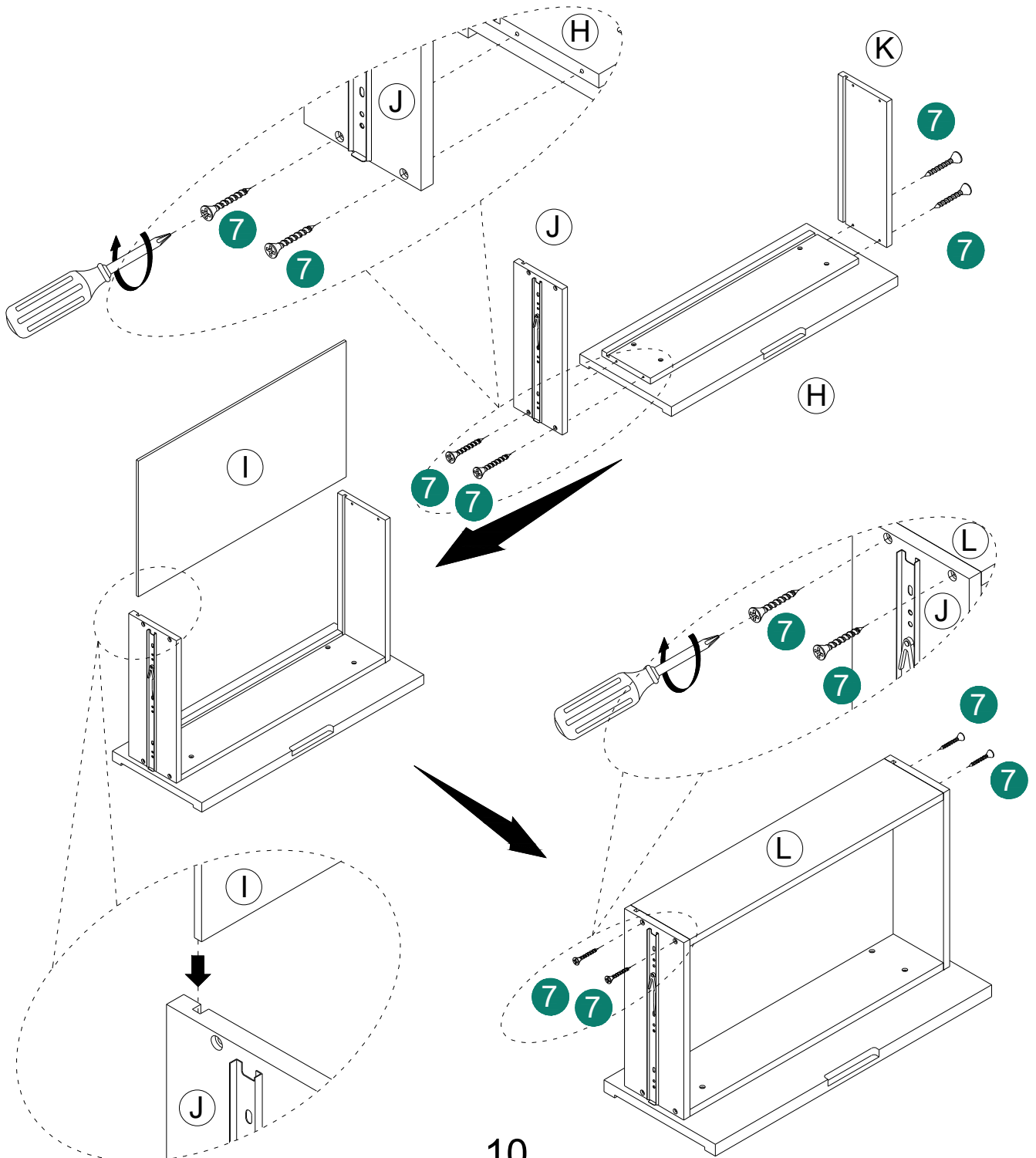
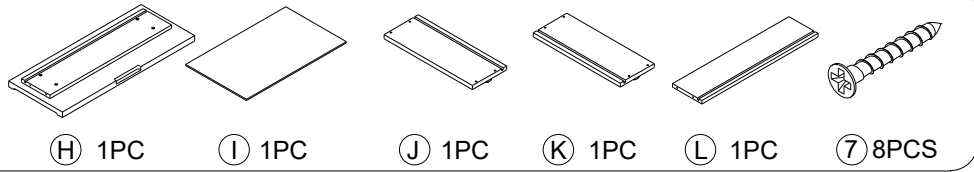

ASSEMBLY INSTRUCTIONS

7

