

PLATFORM BED - TWIN
LIT PLATEFORME - TWIN
N709P183348

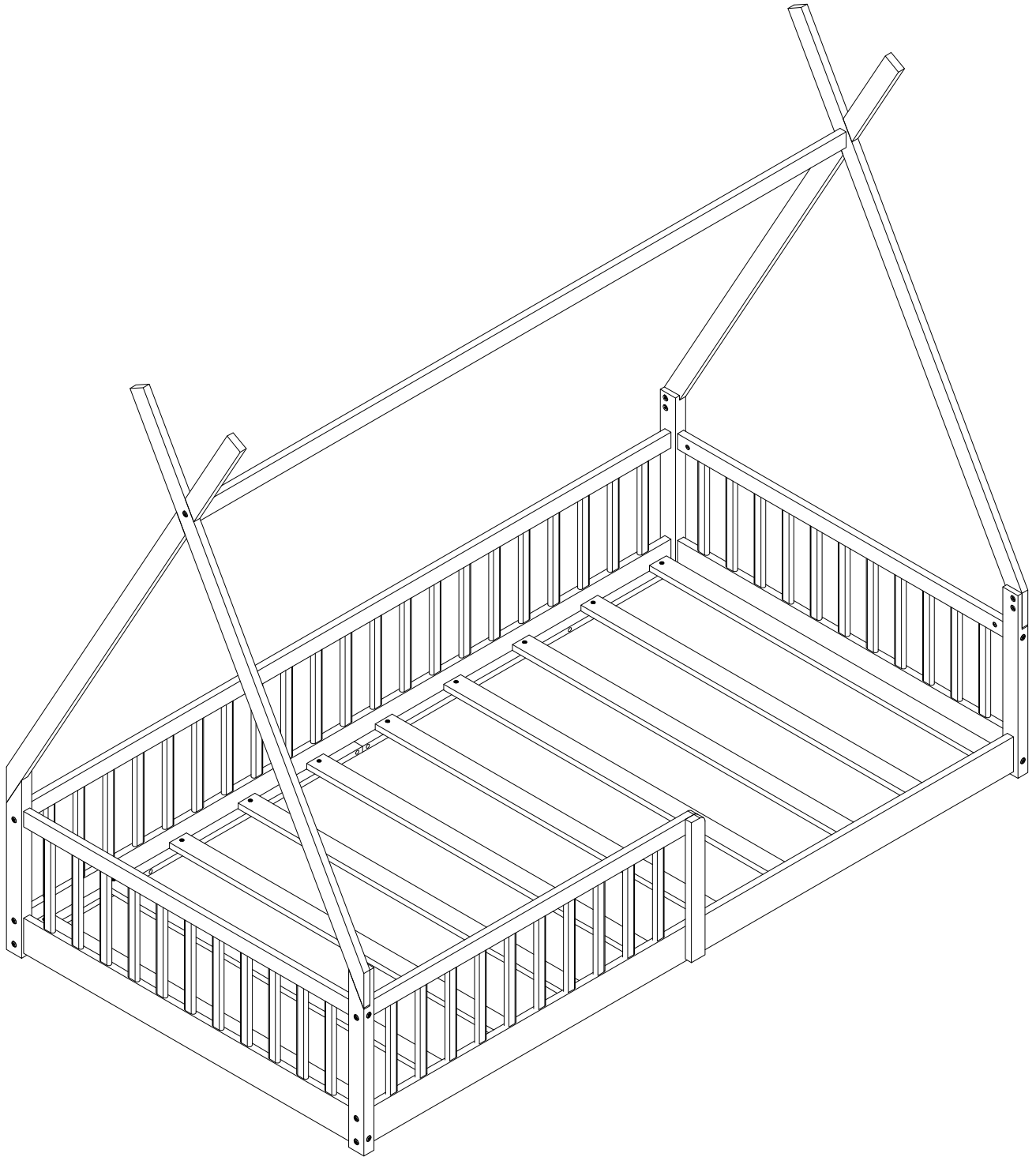

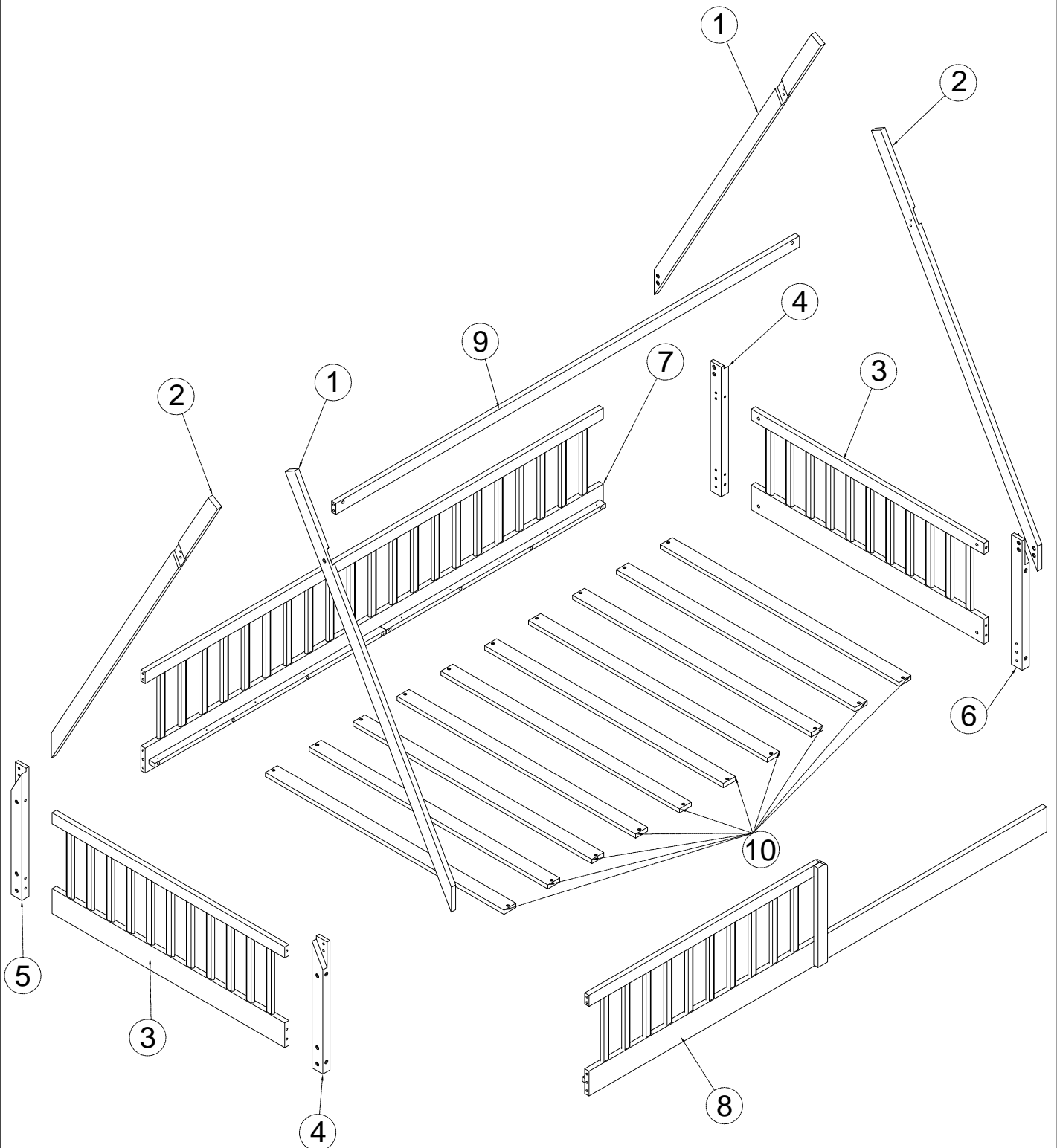



ASSEMBLY INSTRUCTIONS

INSTRUCTIONS DE MONTAGE





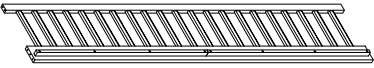
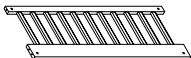
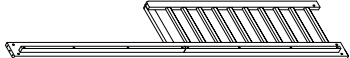
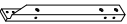

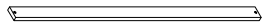
ASSEMBLY INSTRUCTIONS INSTRUCTIONS DE MONTAGE

PARTS LIST LISTE DES PIECES

①	Roof bar front left and rear left Barre de toit avant gauche et arrière droite	2pcs	⑥	Right front leg Jambe avant droite	1pcs
					
②	Roof bar front right and rear left Barre de toit avant droite et arrière gauche	2pcs	⑦	Bed back frame Cadre de dossier de lit	1pcs
					
③	Bed side frame Cadre de côté de lit	2pcs	⑧	Front side rails Barrières latérales avant	1pcs
					
④	Left front leg, right back leg Jambe avant gauche, jambe arrière droite	2pcs	⑨	Front and back bar Barre avant et arrière	1pcs
					
⑤	Left back leg Jambe arrière gauche	1pcs	⑩	Bed slats Murs du lit	10pcs
					

HARDWARE LIST LISTE DE MATÉRIEL

A	M6*75mm		21PCS	D	M6*20mm		8PCS
B	L4*58		1PCS	E	M4X25mm		20PCS
C	Ø8X30mm		13PCS				

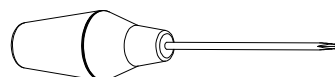

ASSEMBLY TOOLS REQUIRED (NOT INCLUDED)

OUTILS D'ASSEMBLAGE REQUIS (NON INCLUS)



ASSEMBLY INSTRUCTIONS INSTRUCTIONS DE MONTAGE

STEP 1 ÉTAPE 1

(A)	M6*75mm		4PCS
(C)	Ø8X30mm		2PCS

(B)	L4*58		1PCS
-----	-------	---	------

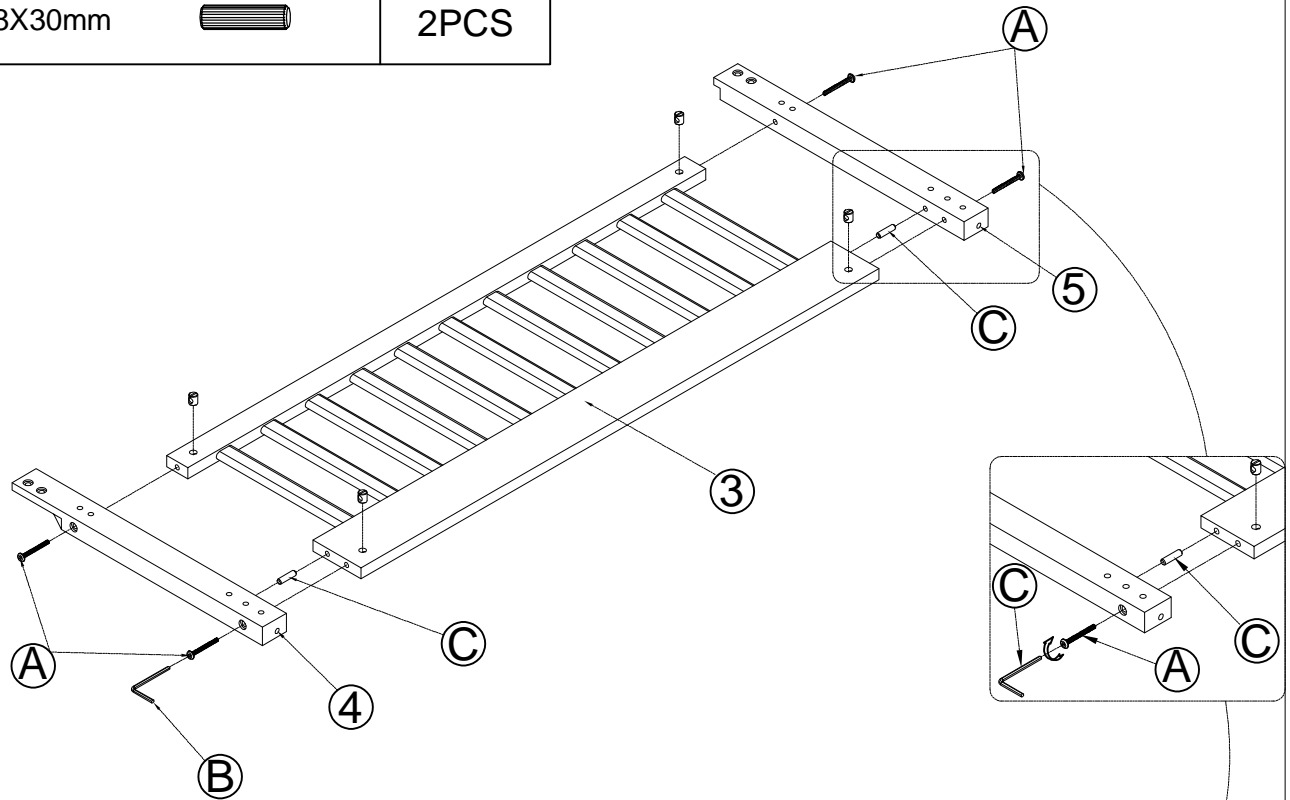

STEP 2 ÉTAPE 2

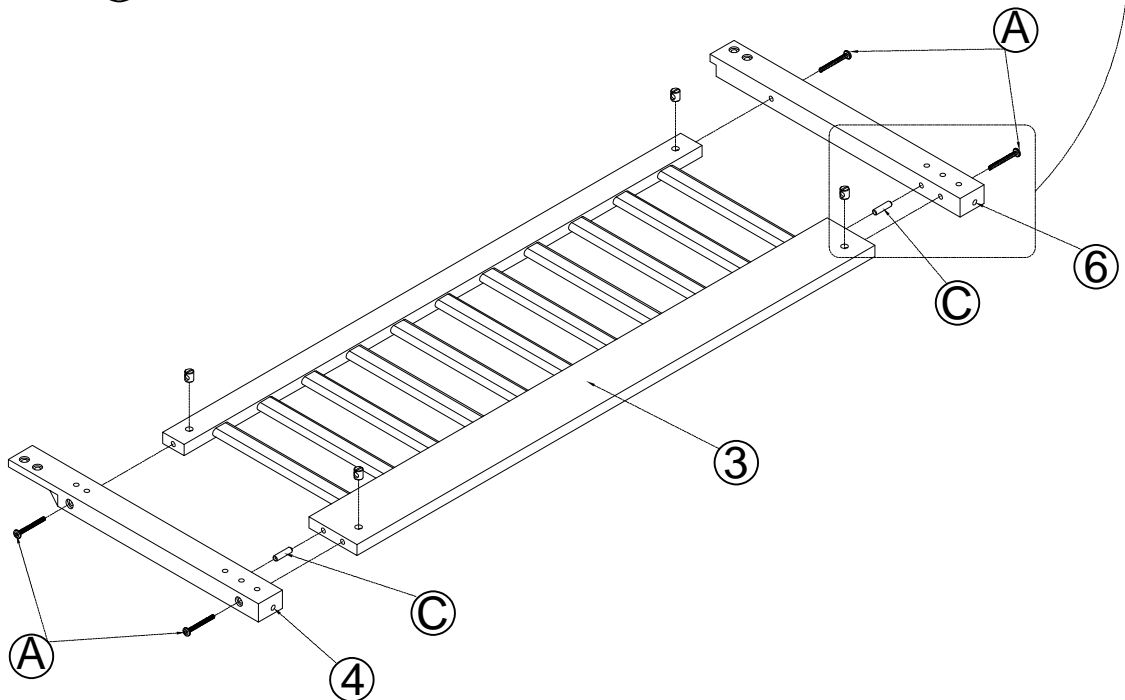



(A)	M6*75mm		4PCS
-----	---------	---	------

(C)	Ø8X30mm		2PCS
-----	---------	---	------

ASSEMBLY INSTRUCTIONS INSTRUCTIONS DE MONTAGE

STEP 3 ÉTAPE 3

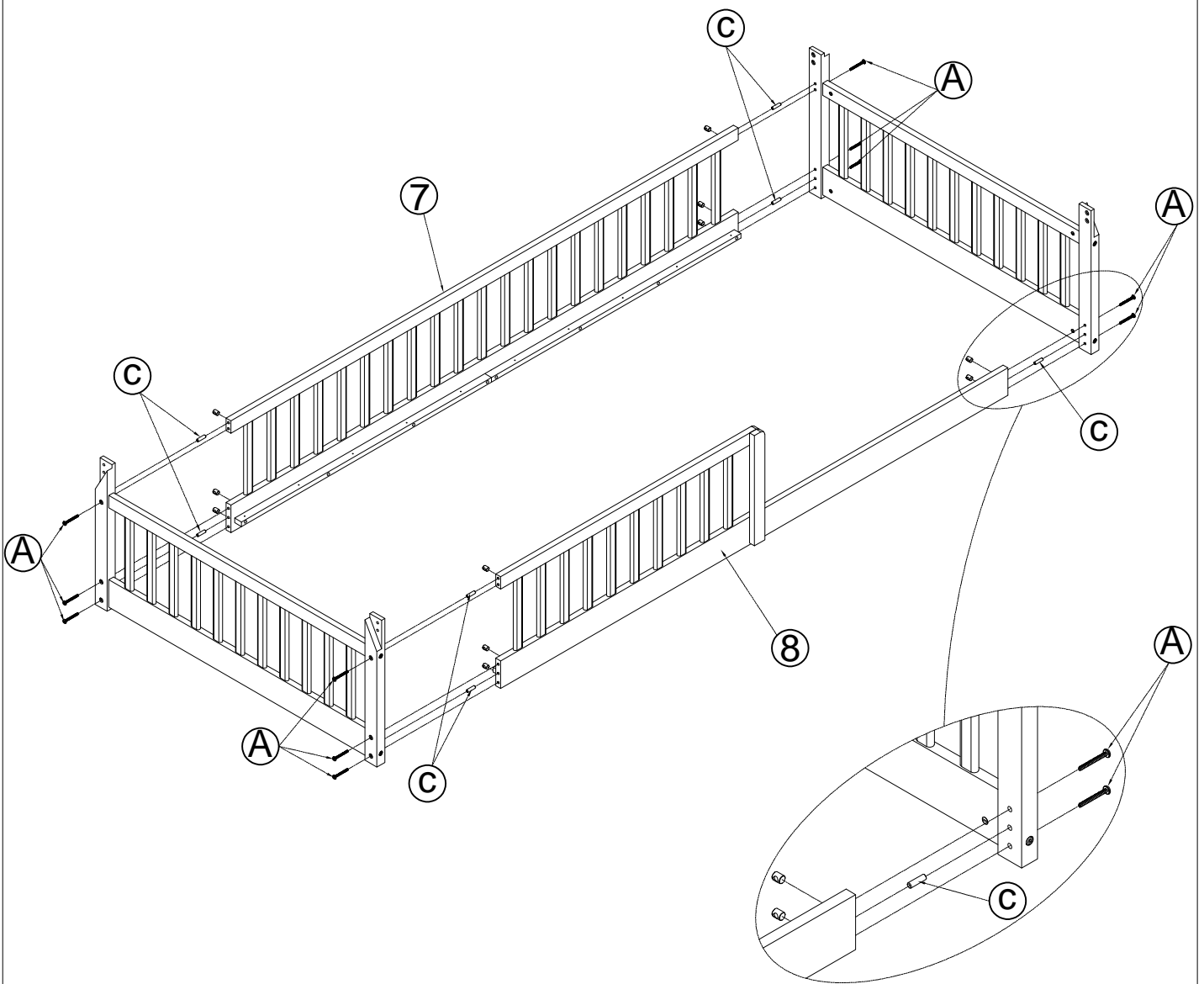

(A)	M6*75mm		11PCS
------------	---------	---	-------

(C)	Ø8X30mm		7PCS
------------	---------	---	------



ASSEMBLY INSTRUCTIONS INSTRUCTIONS DE MONTAGE

STEP 4 ÉTAPE 4

(A)	M6*75mm		2PCS
(D)	M6*20mm		8PCS

(C)	Ø8X30mm		2PCS
------------	---------	---	------

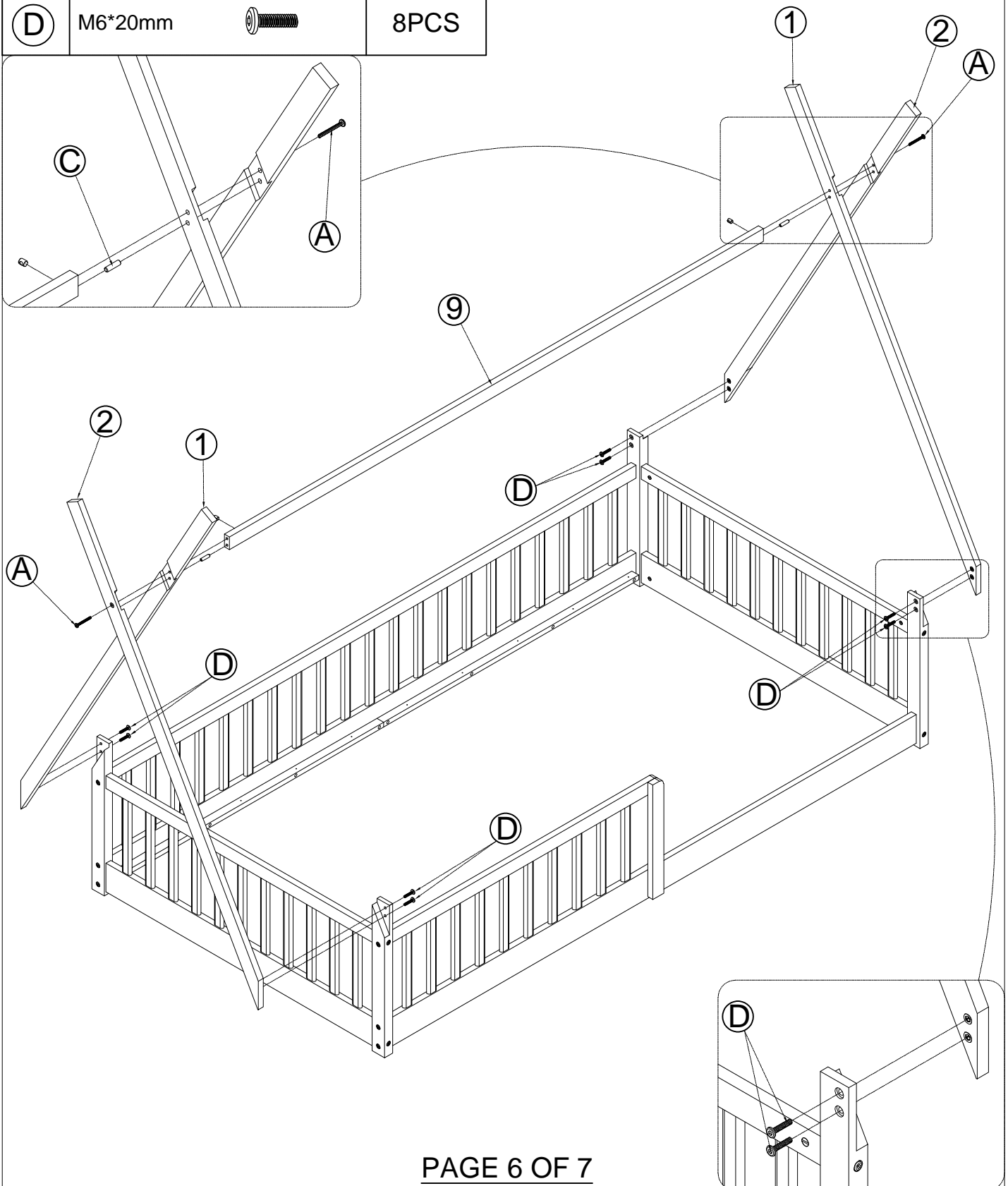

ASSEMBLY INSTRUCTIONS INSTRUCTIONS DE MONTAGE

STEP 5 ÉTAPE 5

E

M4X25mm



20PC

