

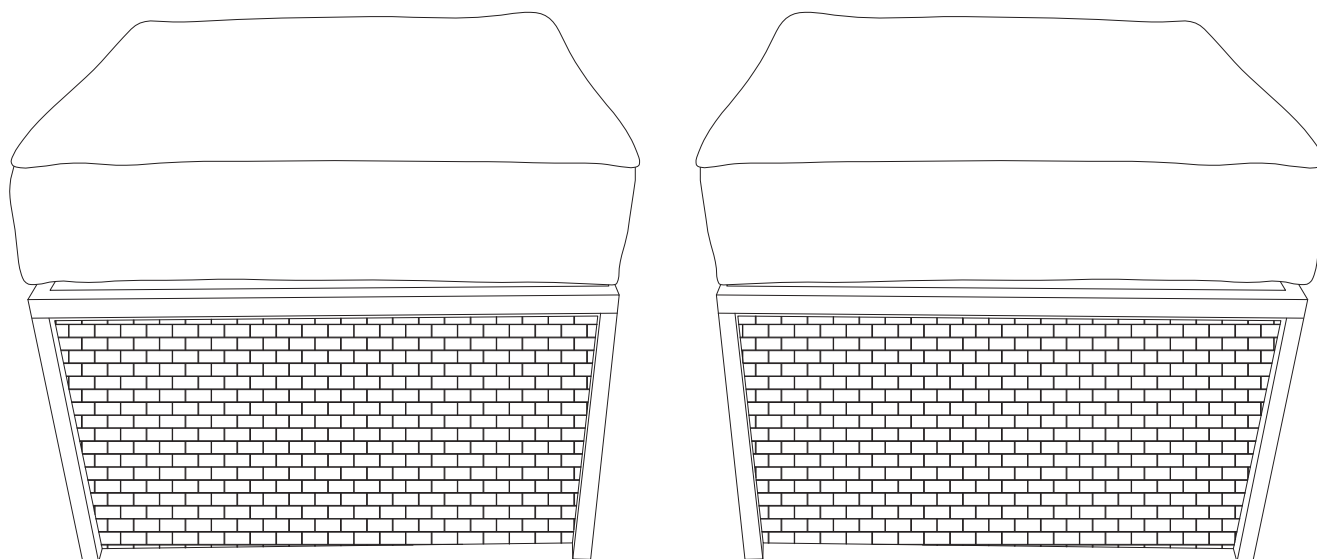



2 Pieces Patio Ottomans

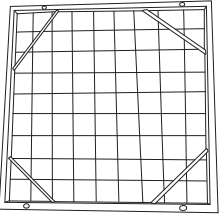
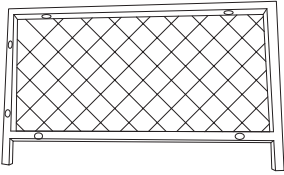
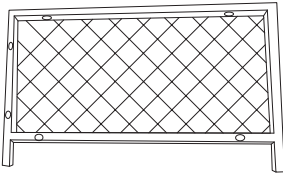
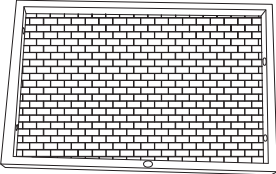
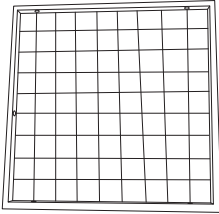
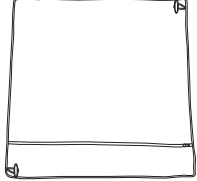

DEAR CUSTOMER,

Thank you for choosing our product. Please read this manual carefully before assembling or using the product, to avoid damage caused by improper use. If the product is passed on to third parties, this manual has to be passed on along with the product. For any question don't hesitate to contact us.

PARTS LIST

| | | |
|---------------------------------------------------------------------------------------------------------------------|------------------------------------------------------------------------------------------------------------------------|---------------------------------------------------------------------------------------------------------------------------|
| A  TOP PANEL × 2 | B  SIDE PANEL (LEFT) × 2 | C  SIDE PANEL (RIGHT) × 2 |
| D  BACK PANEL × 2 | E  BOTTOM PANEL × 2 | F  SEAT CUSHION × 2 |
| G  M6*30 BOLT × 26 | H  WASHER × 26 | I  ALLEN WRENCH × 1 |

EXPLODED VIEW DRAWING

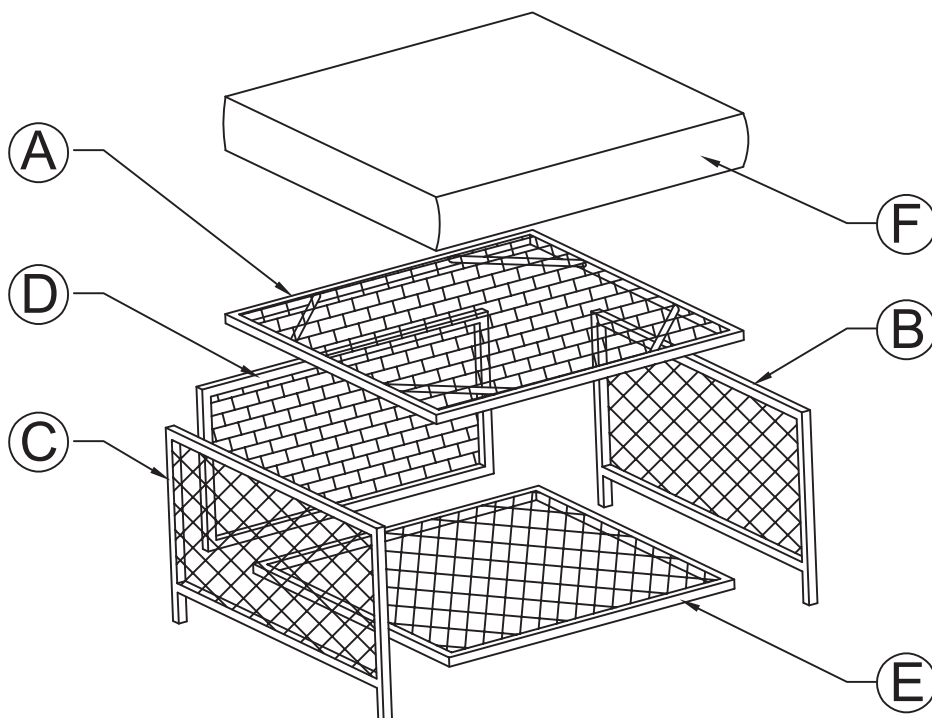

ASSEMBLY INSTRUCTION

ASSEMBLY REQUIREMENT



1 PERSON
ASSEMBLY

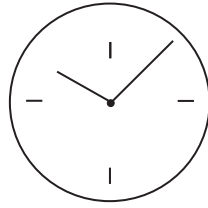

UP TO 20 MIN.
ASSEMBLY

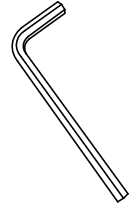

TOOL NEEDED
(PROVIDED)

⚠ ATTENTION

Before Assembly

- Make sure you received all parts on the parts list. If you find something missing, please stop assembling and contact our customer service immediately. We will solve your issue as soon as possible.
- Please read through this booklet carefully before assembly.
- Please choose an empty space that is clean, flat, and steady for assembly to avoid damaging or staining the product.





During Assembly

- When assembling the product, please keep all small parts and package materials away from babies and children.
- In each step, do not tighten up bolts until you confirm all bolts are lined up with their corresponding holes.

After Assembly

- Keep this booklet for future reference.
- Do not dispose of the packaging materials if you want to return the product.
- Improper use of this product or failure to follow the instructions may result in injury.

STEP 1 Connect side panels(B&C) to top panel(A)

| | | | | | |
|---|-----------------------------------------------------------------------------------|-----|---|--------------------------------------------------------------------------------------------|-----|
| A |  | 1PC | G |  M6*30 | 4PC |
| B |  | 1PC | H |  | 4PC |
| C |  | 1PC | | | |

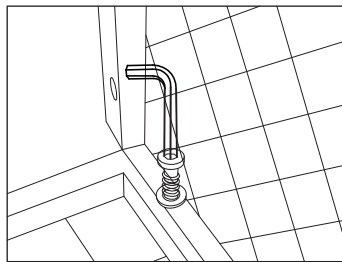

- 1.Lay the Top panel flat on the ground, making sure the side with the holes is facing up.
- 2.Use bolts and washers to connect the Side panels to the bottom panel one by one. Please do not tighten the bolts right now.
- 3.After making sure all the bolts are aligned with the holes, use Allen wrench to tighten the 4 bolts.

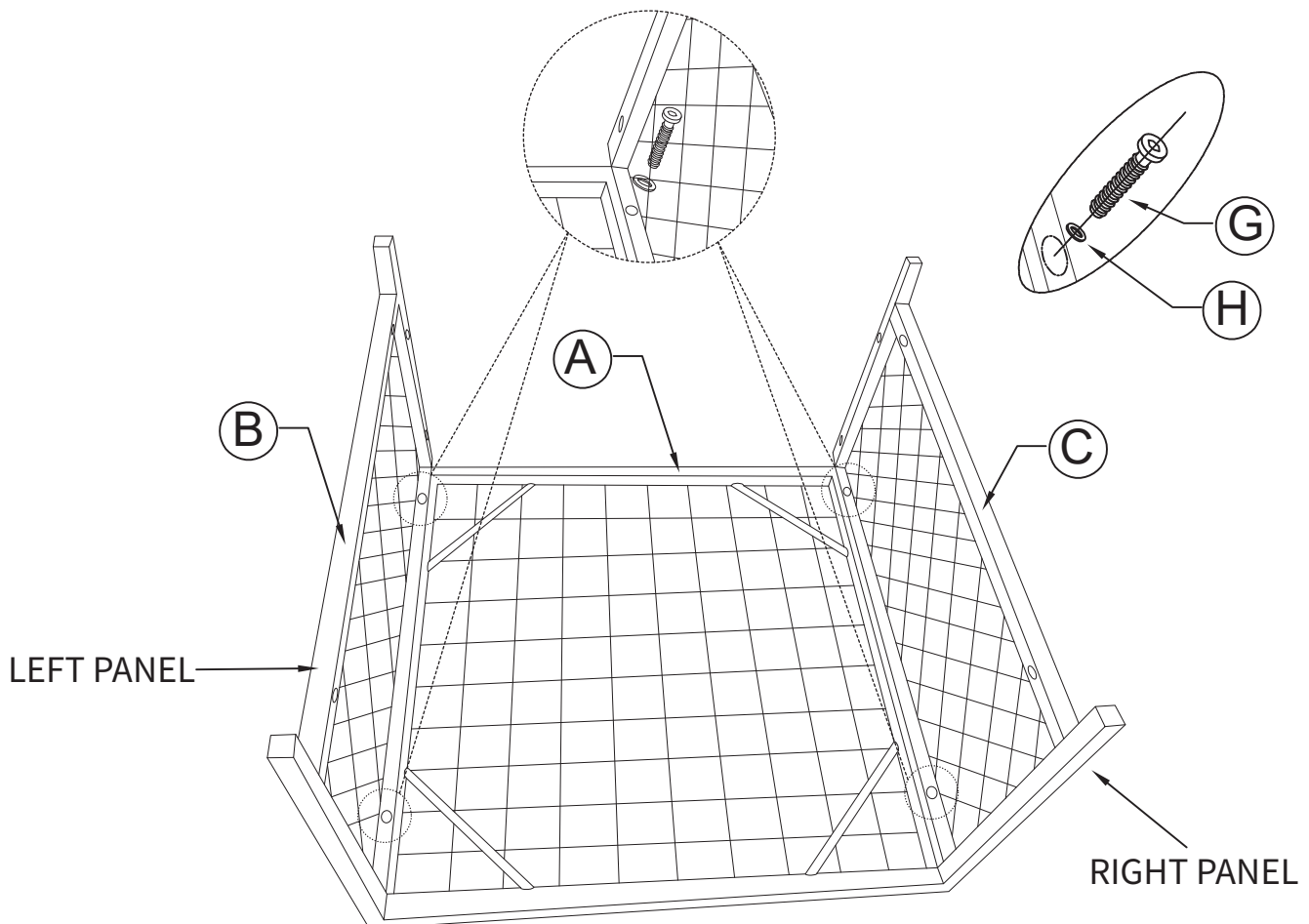

- 4.Please shake the Side panels slightly to ensure that all bolts are fully tightened.



STEP 2 Connect the back panel(D)

| | | |
|---|--------------------------------------------------------------------------------------------|-----|
| D |  | 1PC |
| G |  M6*30 | 4PC |
| H |  | 4PC |

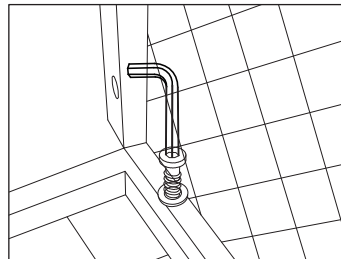

1. Place the Back panel between the fixed Side panels.
2. Gently rotate the bolts. Please do not tighten the bolts right now.
3. After making sure all the bolts are aligned with the holes and there is no gap between the top and back panels, use the Allen wrench to tighten the 4 bolts.

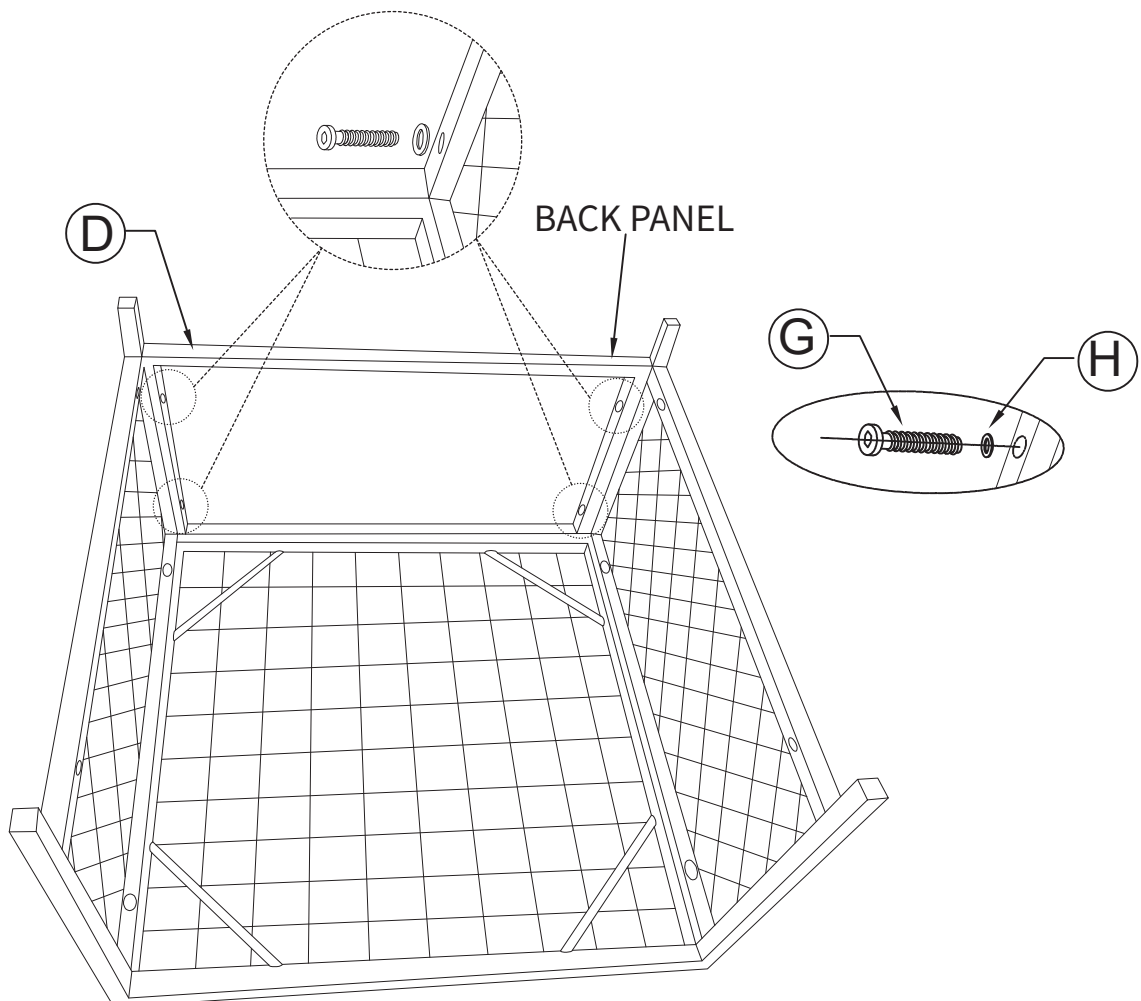

4. Slightly shake the Back panel to ensure that it is successfully connected.



STEP 3 Connect the bottom panel(E)

| | | |
|---|--------------------------------------------------------------------------------------------|-----|
| E |  | 1PC |
| G |  M6*30 | 5PC |
| H |  | 5PC |

- 1.Place the Bottom panel between the fixed Side panels and fixed Back panel.
- 2.Gently rotate the bolts. Please do not tighten the bolts right now.
- 3.After making sure all the bolts are aligned with the holes and there is no gaps, use the Allen wrench to tighten the 5 bolts.

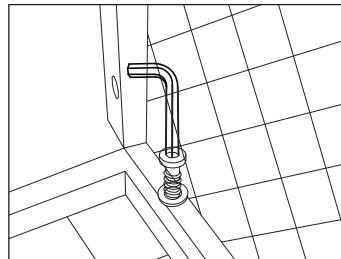

- 4.Slightly shake the Back panel to ensure that the Back panel is successfully connected.

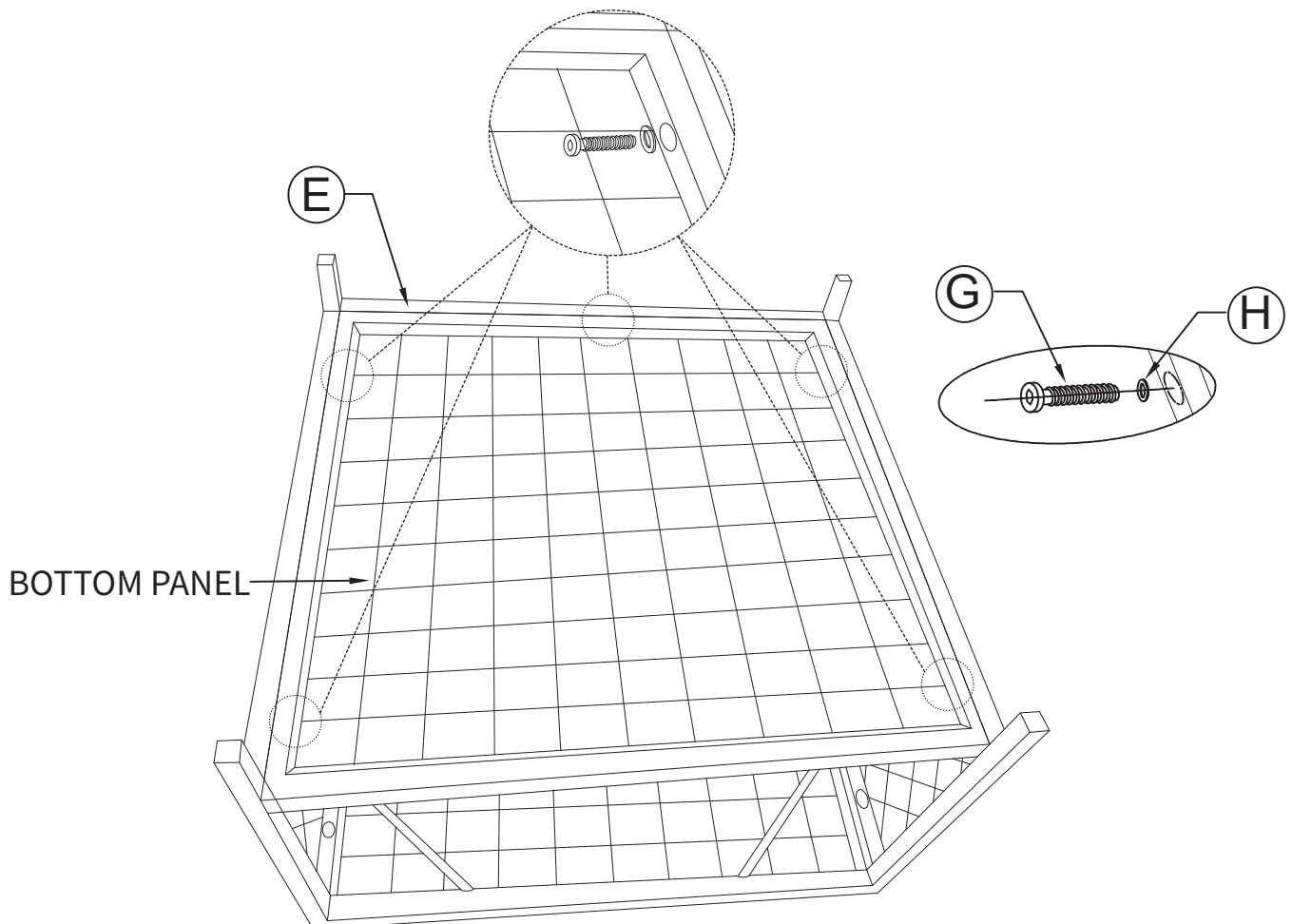

STEP 4 Turn over and add seat cushion

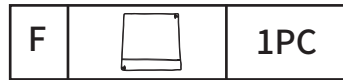

1. Turn the product over.
2. Gently press the Top panel to ensure that all panel are firmly connected.
3. Use the 2 buckles under the seat cushion to fix the seat cushion to the top panel.

