

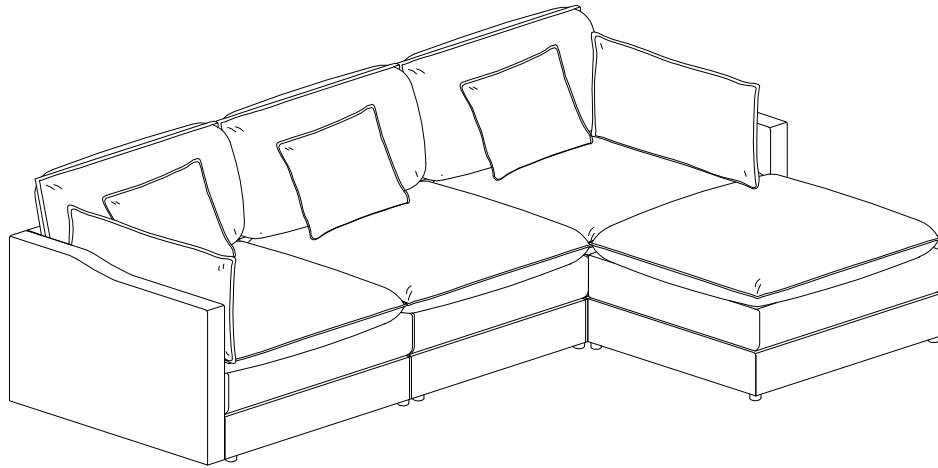

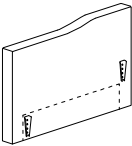

# ASSEMBLY INSTRUCTIONS

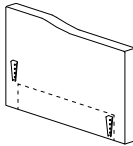
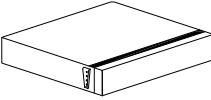
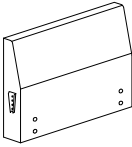
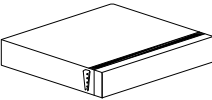
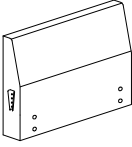
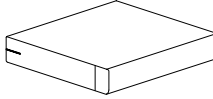
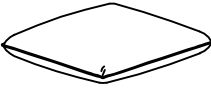

253

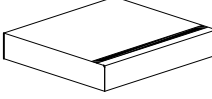
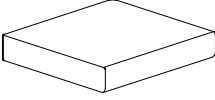
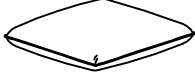

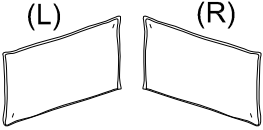
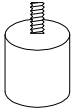
## Parts List

				
<b>Ax1</b>	<b>Bx1</b>	<b>Cx2</b>	<b>Dx2</b>	<b>Ex1</b>
				
<b>Fx1</b>	<b>Gx3</b>	<b>Hx3</b>	<b>Ix3</b>	<b>Jx1</b>
				
<b>Kx1</b>	<b>Lx1</b>	<b>Mx3</b>	<b>Nx2</b>	<b>Ox22</b>

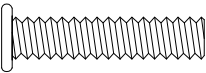
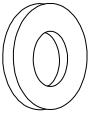
## Hardware List

		
m8*60mm	m8*22mm	
<b>1</b> -Bolt (12pcs)	<b>2</b> -Flat Washer (12pcs)	<b>3</b> -AllenKey(1pc)

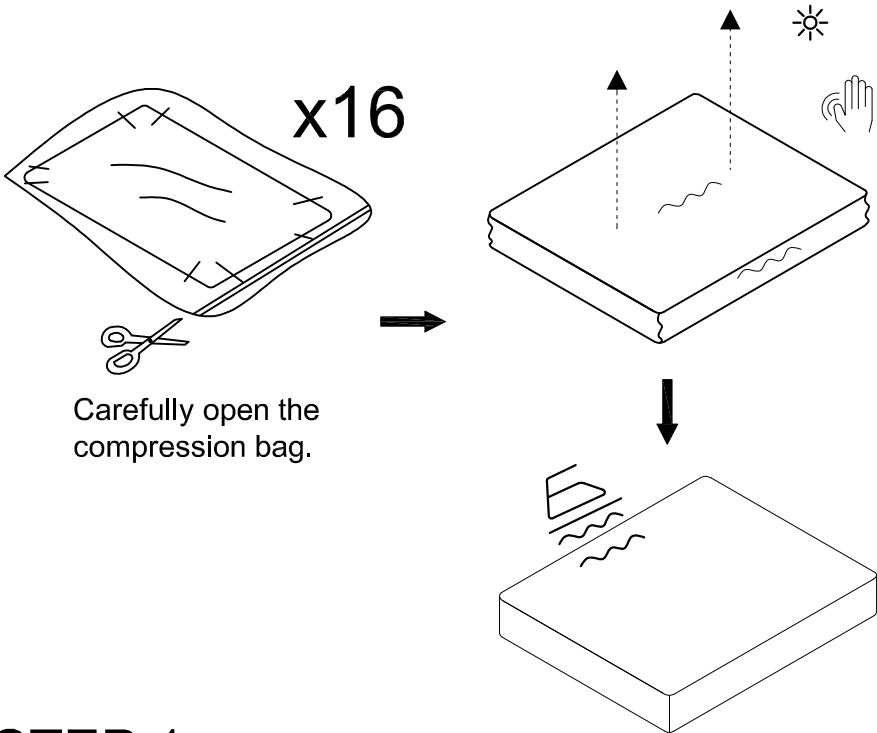
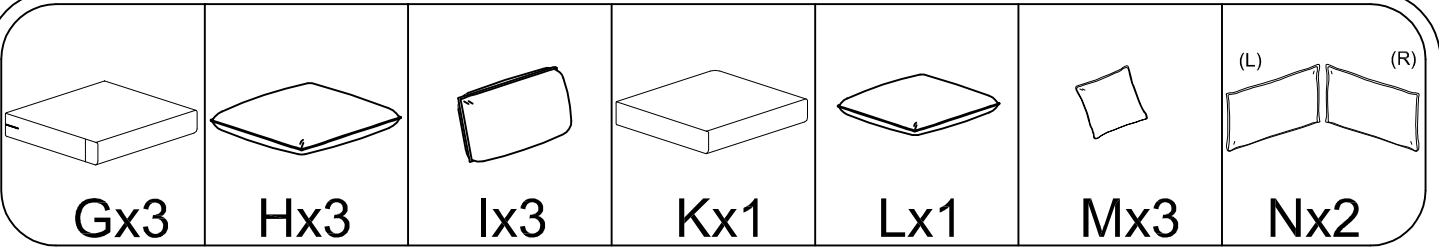
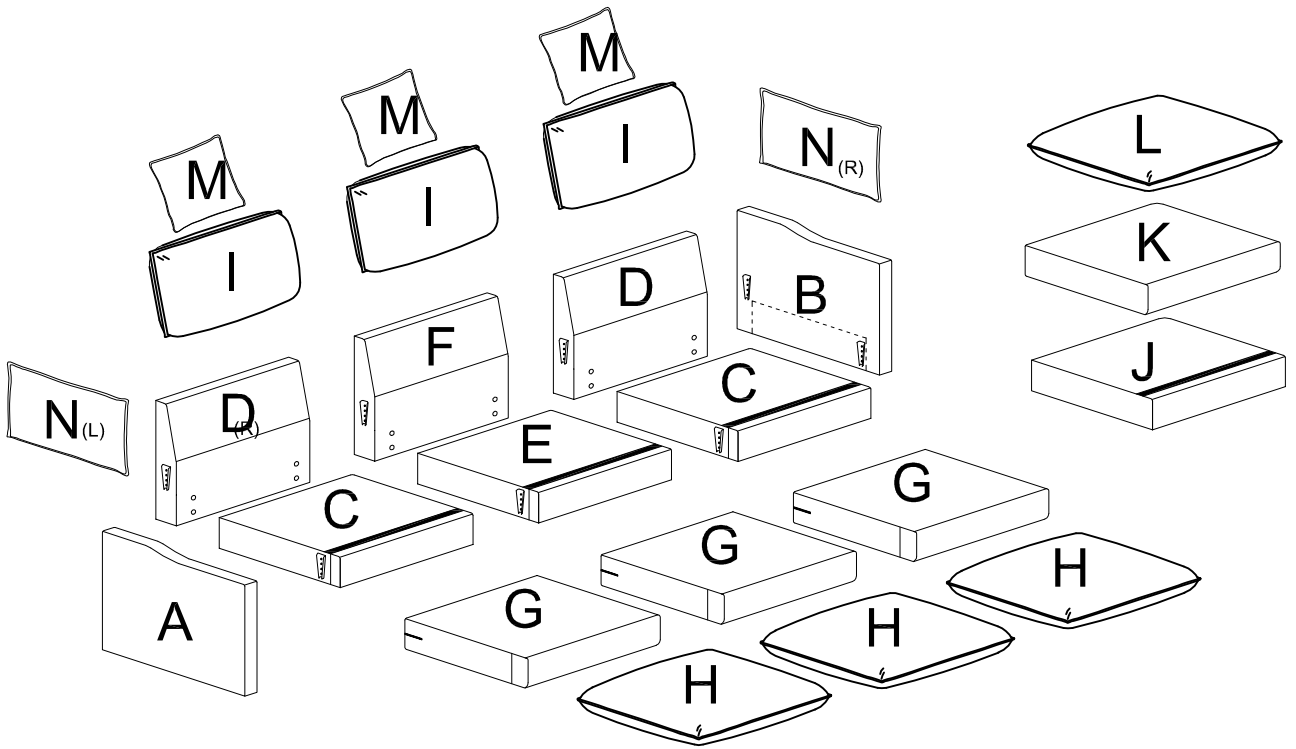

Vigorously beating the sofa and placing it in the sunlight helps the sofa regain its original shape.

If there are wrinkles, you can use an iron to smooth them out.

**STEP 1**

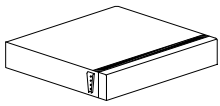

Cx2

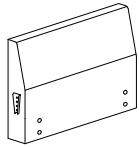

Dx2

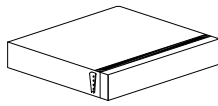

Ex1

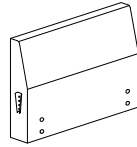

Fx1

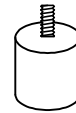

Ox18

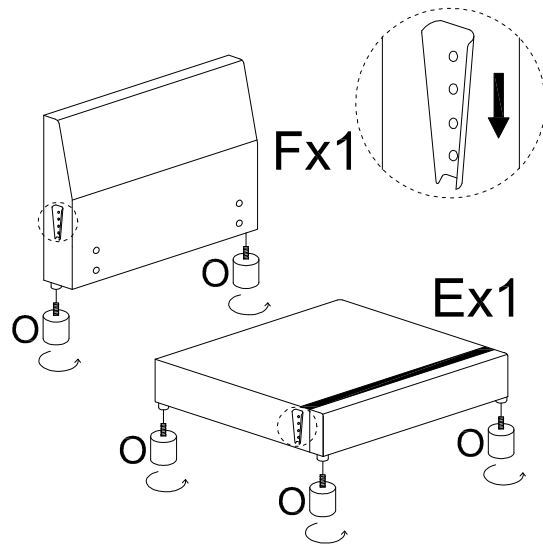
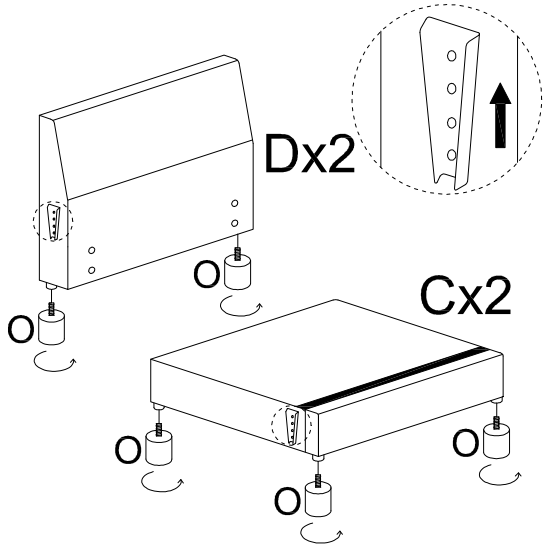

STEP 2

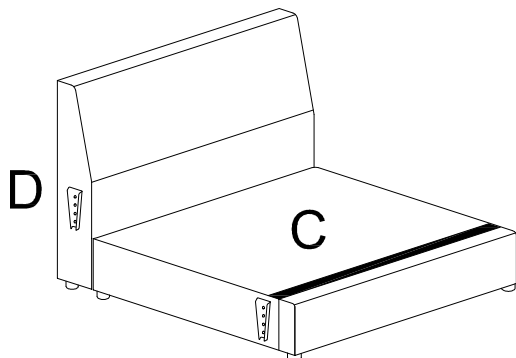
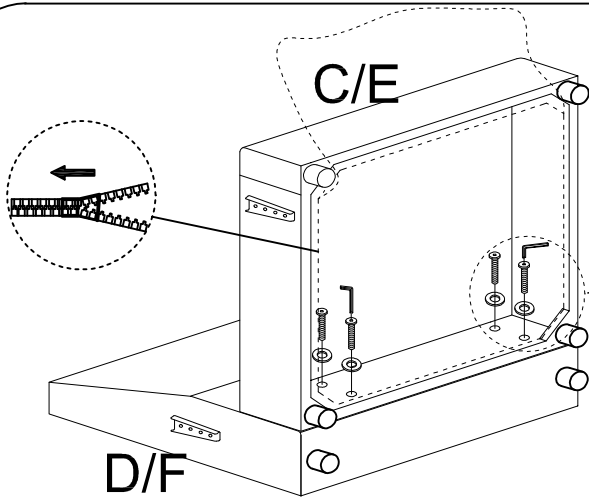

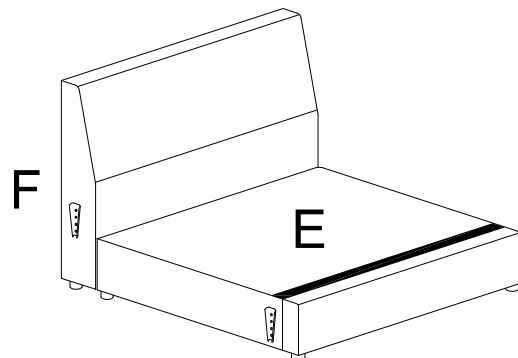

x2

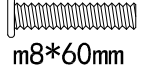

x1

STEP 3

 m8*60mm	1 x 12PCS
	2 x 12PCS
	3 x 1PC

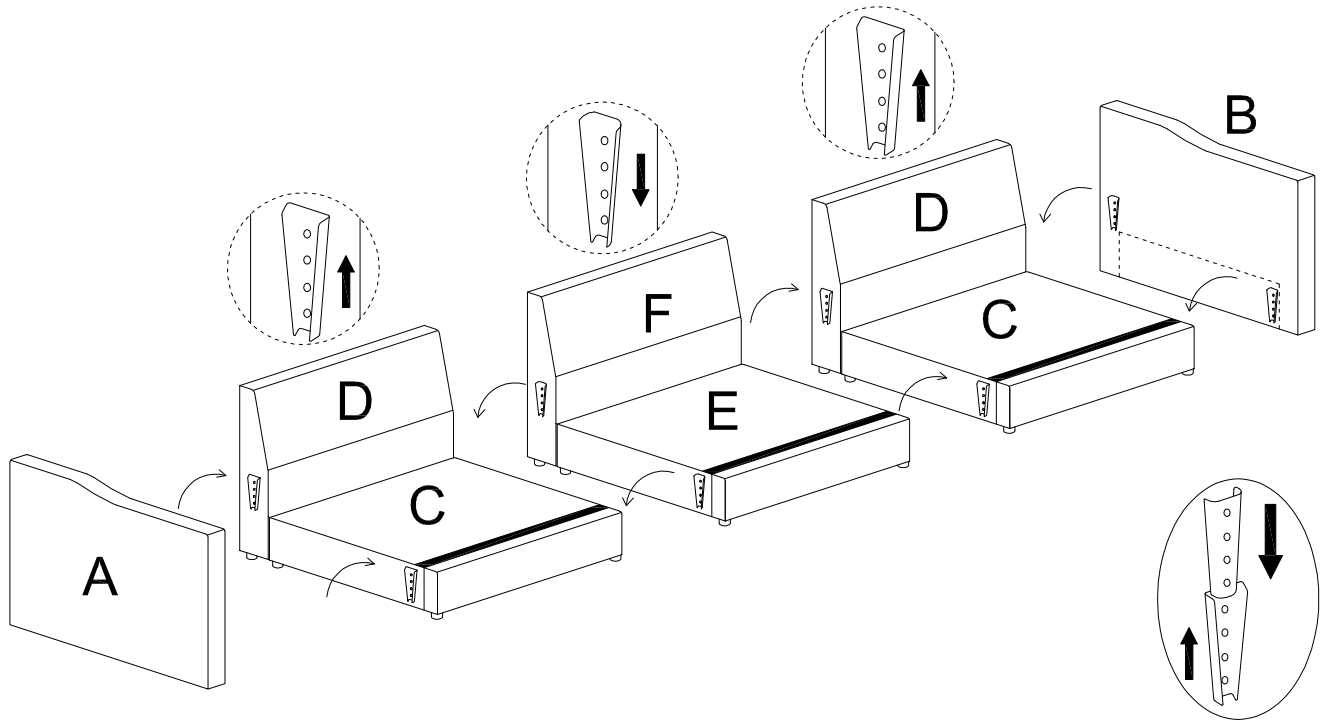

**STEP 4**

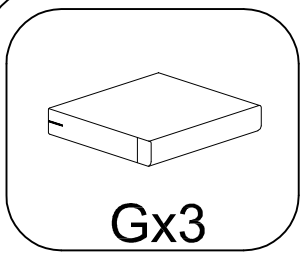

**Gx3**

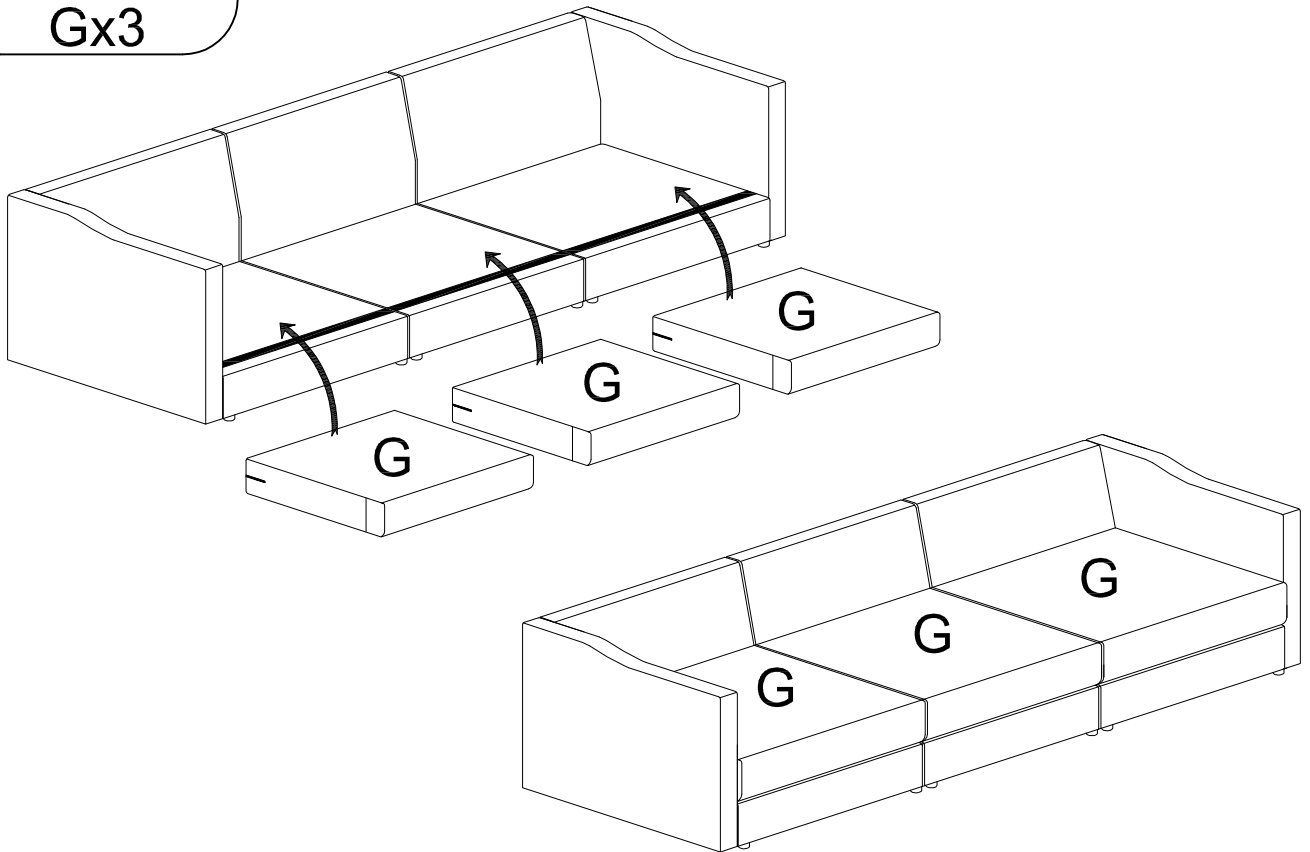

**STEP 5**

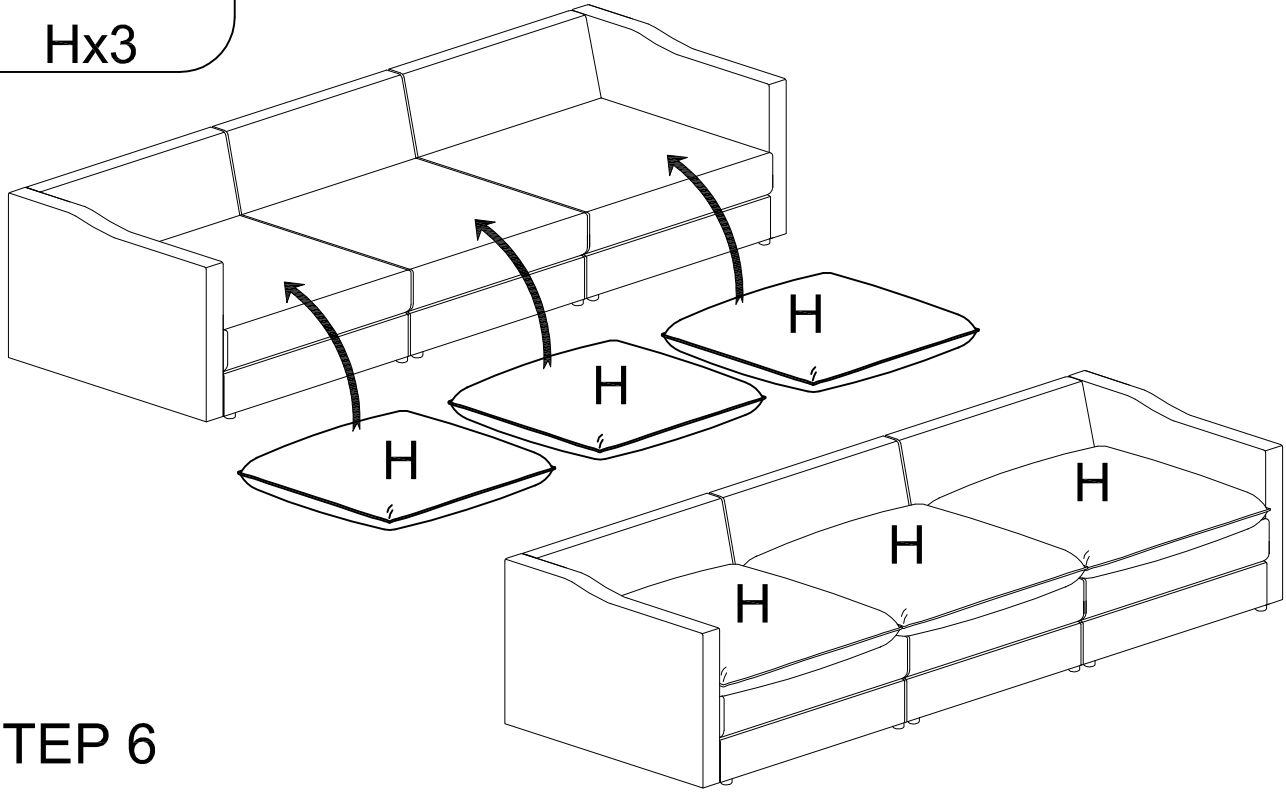
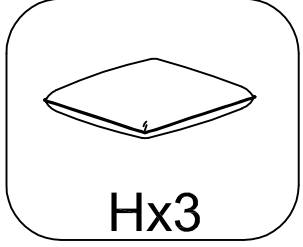

STEP 6

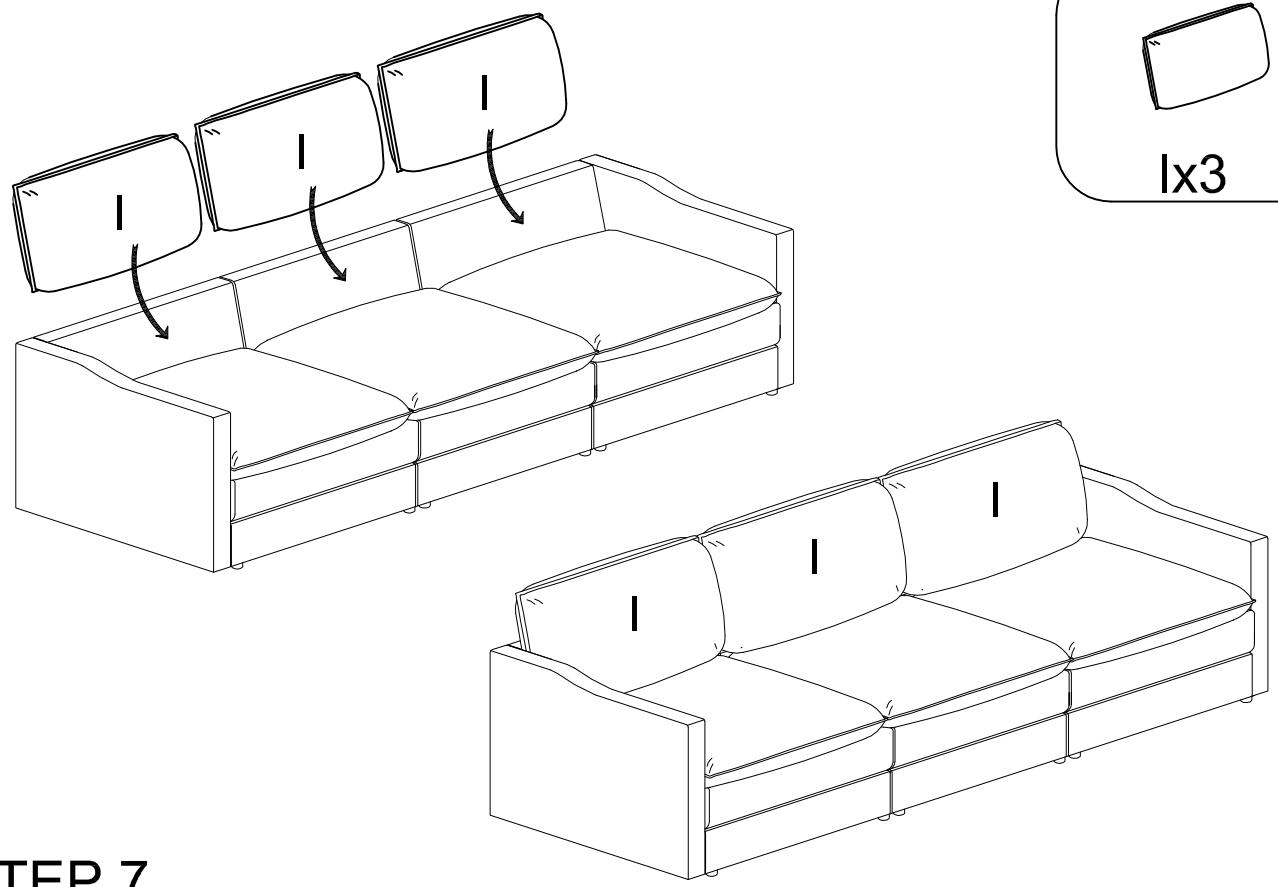
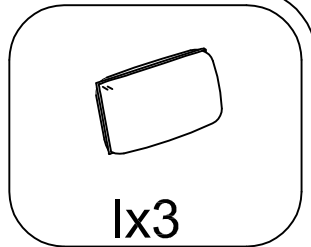

STEP 7

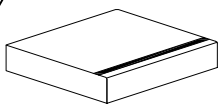

Jx1

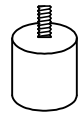

Ox4

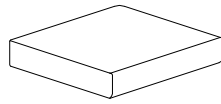

Kx1



Lx1

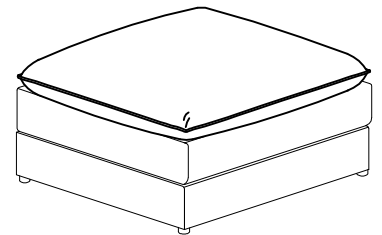
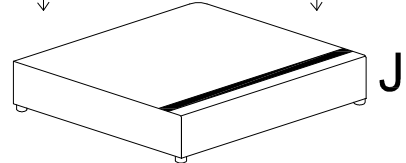
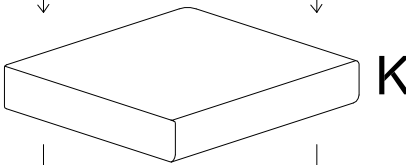
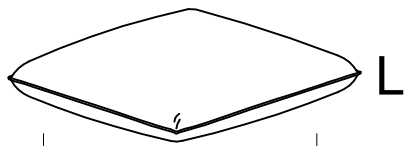
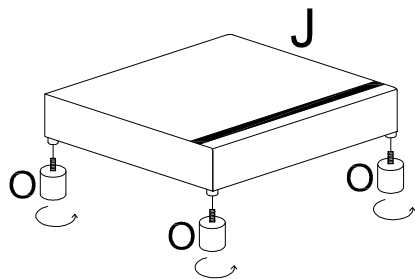

STEP 8



Mx3

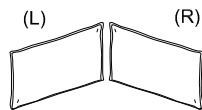

Nx2

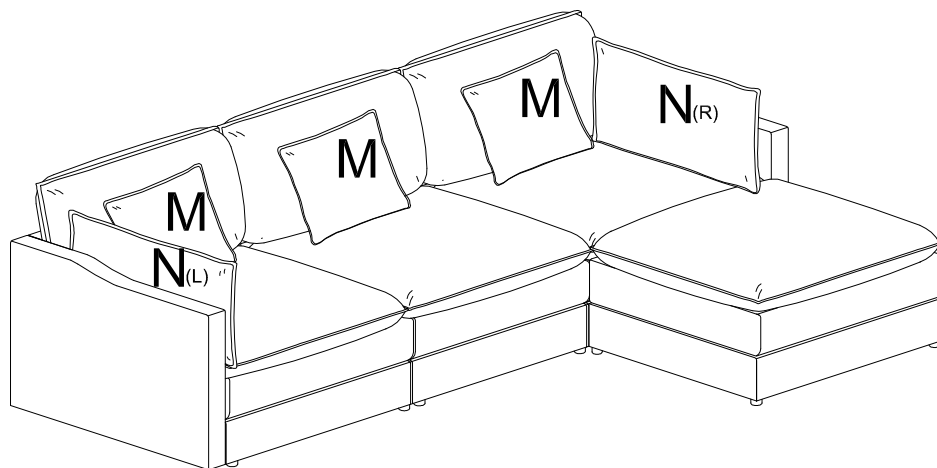

STEP 9