







# ASSEMBLY INSTRUCTION

## ITEM NO: 194S9648GY/SN-2

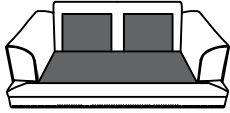
### LOVE SEAT

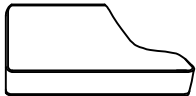
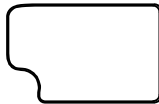
**NOTE: Do not use power tools for assembly. Power tools increase the risk of over tightening which leads to splitting or cracking the wood.**

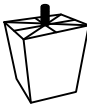
#### COMPONENT LIST (LOVE SEAT)

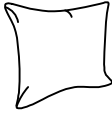
NO.	DRAWING	QTY	DESCRIPTION
A		1	SEAT
B		1	LSF SEAT CUSHION
C		1	RSF SEAT CUSHION
D		1	LSF BACK CUSHION
E		1	RSF BACK CUSHION
F		4	PLASTIC LEGS 3.74"x2.75"x3.14"
G		4	WASHERS 1.85"x0.39"x0.07"
H		4	PILLOWS 20"x20"

**STEP# 1**

Turn Plastic Leg (F) and Washers (G) until fully tightened.

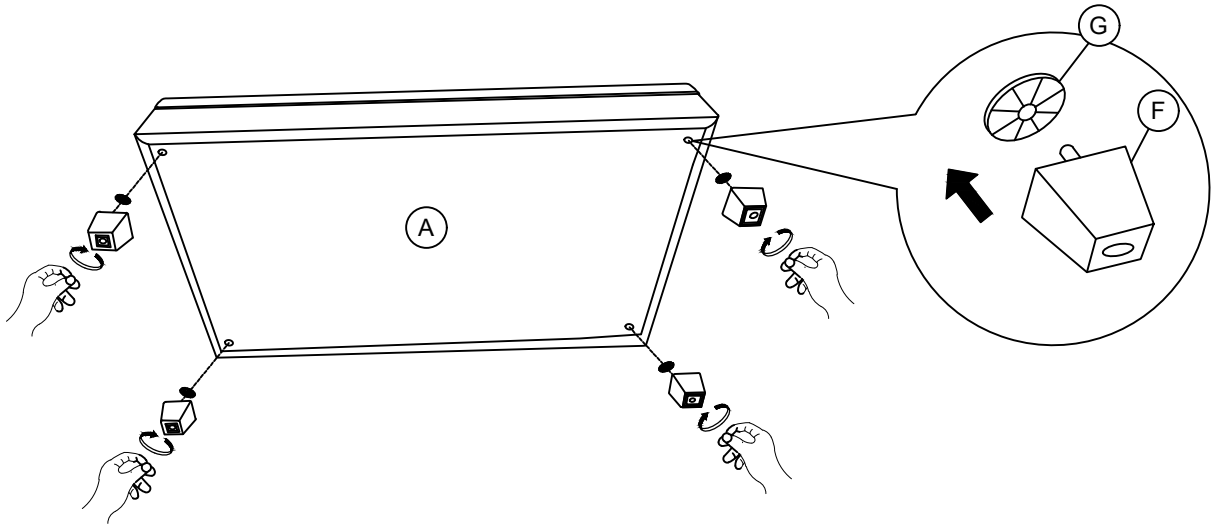

**STEP# 2**

Attach LSF Seat Cushion (B) & RSF Seat Cushion (C) to the Seat (A).

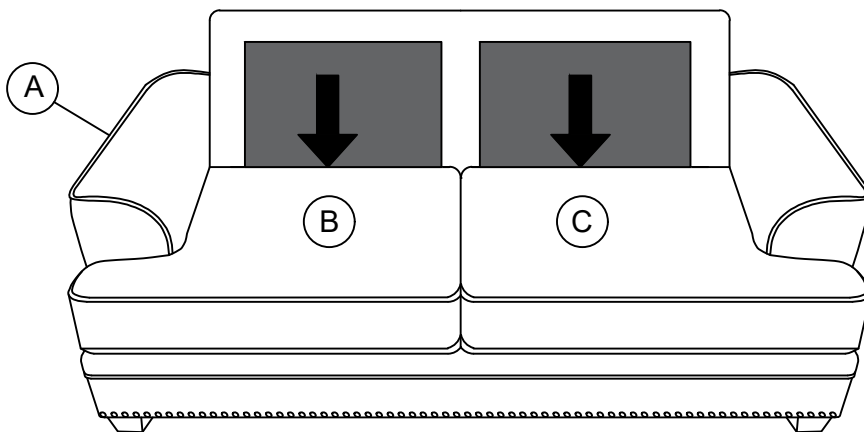

### STEP# 3

Attach LSF Back Cushion (D) & RSF Back Cushion (E) to the Seat (A) .

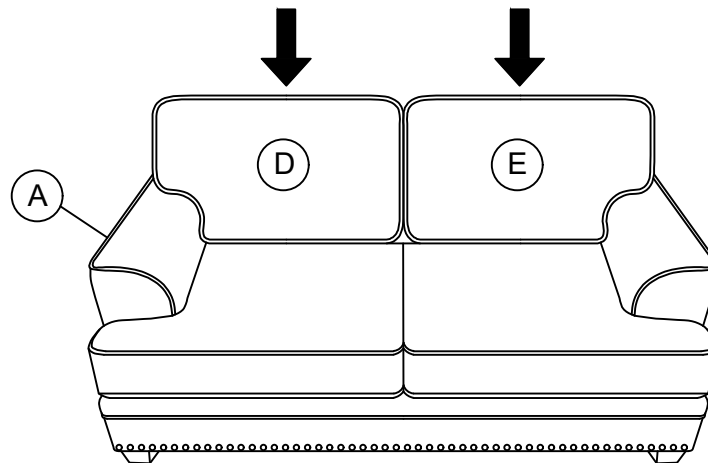

### STEP# 3

Completed .

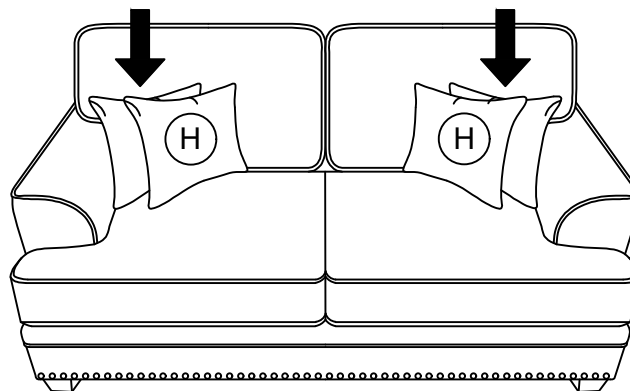

### Care Instruction for Textured Furniture.

In order to maintain the original appearance of your Textured furniture, please follow below simple care procedures:

- Avoid exposing furniture directly to sunlight or heating and air conditioning outlets. Sunlight and/or exposure to heating and air conditioning outlets will fade/damage Textured.
- Do not place your Textured furniture too close to windows, radiators, or vents.
- Vacuum or wipe with a soft brush to remove dust.
- Hardware may loosen over time. Periodically check to make sure all connection are tight, Re-tighten if necessary.



**For items use on wooden floor, hard surfaces or carpets, it is recommended to install protective pads under all legs and supports to avoid/prevent from damages/scratches and discoloration.**