

Living Essentials

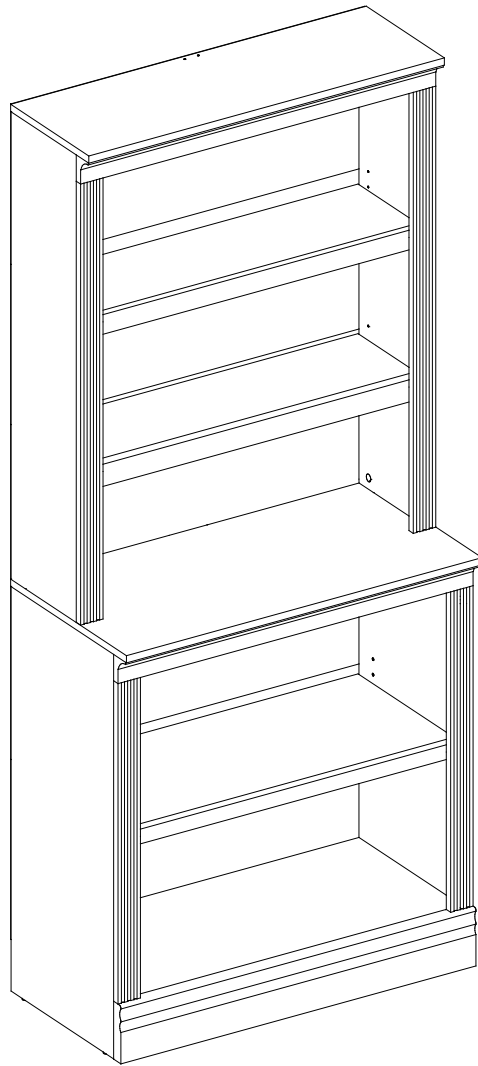

HALSTON MULTI-DEPTH BOOKCASE

SKU# BKCWWH0131, BKCWOK0131, BKCWDC0131

Assembly Instructions



LivingEssentials

***For faster service:
Please contact Living Essentials
Regarding any defective product(s) / Part(s).***

***Our Customer Service Representative will assist you
through the process of obtaining replacement part(s) .***

***Visit our website and fill out the Parts & Service Form.
Give us a call, or email us for replacement parts at:***

**1-888-818-8789
rma@livingess.com**

LIVING ESSENTIALS
1040 Walnut Ave.
Pomona CA 91766
Attention: Customer Service Department

Limited Warranty

LIVING ESSENTIALS products are warranted to be free from defects in material and workmanship for a period of ONE YEAR: One-year warranty from date of original purchase by consumer. If you believe your product is defective, please call, write, or e-mail our customer service department.

Should your product be defective, LIVING ESSENTIALS will help in issuing replacement parts. Whether you call or write, please have your model number and reference number located on the original packaging ready for our customer service team. You will be asked to tell us what product you have, along with the date of purchase and the way you believe the product is defective. For any parts request, it must include images of the defective part/s. Please do not ship your product back to us unless we specifically request you to do so. If it is necessary for your product to be returned, all returns or exchanges must be made through the original store of purchase. Proof of purchase must accompany the returned product. LIVING ESSENTIALS is not responsible for any store policies for returns or exchanges.

Note: This Warranty does NOT apply to any wear and tear. All replacement parts will be shipped standard ground service. NO EXPEDITED Service available (for example; next day air, 2 day air service, 3 day air), there will NOT be any exceptions.

LIVING ESSENTIALS is not responsible for any consequential damages, which may arise out of the purchase, or use of any of our product/s. LIVING ESSENTIALS is not responsible for any personal injury, or property/equipment damage from the use of such product/s. LIVING ESSENTIALS' liability for any breach of warranty shall be limited to replacement of the defective parts as described above.

Important: Some states do not allow the exclusions or limitations so the above limitations or exclusions may not apply to you.

Copyright by: LIVING ESSENTIALS and its affiliates

Instructions / Instrucciones / Moded' emploi

SKU# BKCWWH0131, BKCWOK0131, BKCWDC0131

Do not tighten bolts completely until the product is fully assembled.
Por favor no apriete los tornillos completamente hasta que el producto este completamente ensamblado.

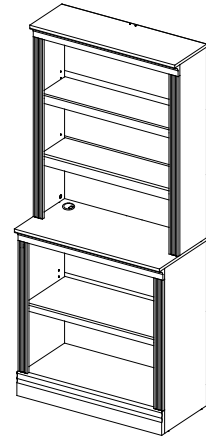

Ax1

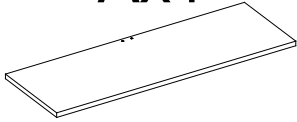

Bx1

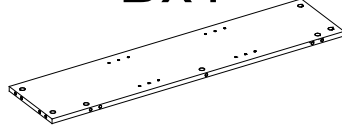

Cx1

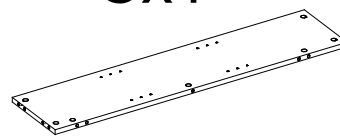

Dx2

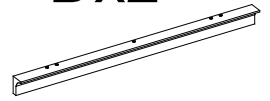

Ex1

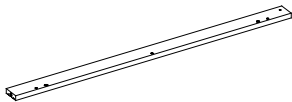

Fx1

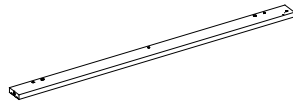

Gx1

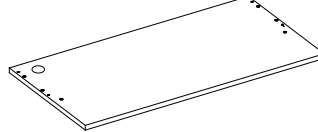

Hx1

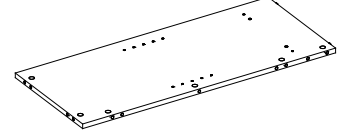

Jx1

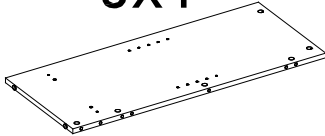

Kx1



Lx1



Mx1

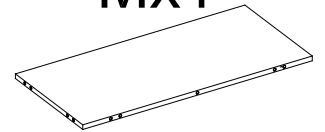

Nx1

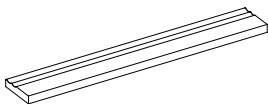

Px1

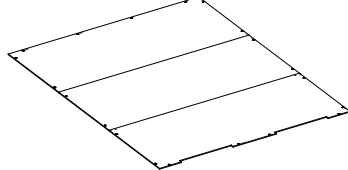

Qx1

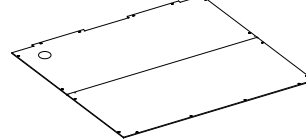

Rx2

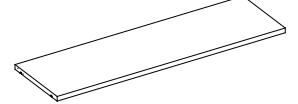

Sx1



Tx3



PACKAGE CONTENTS

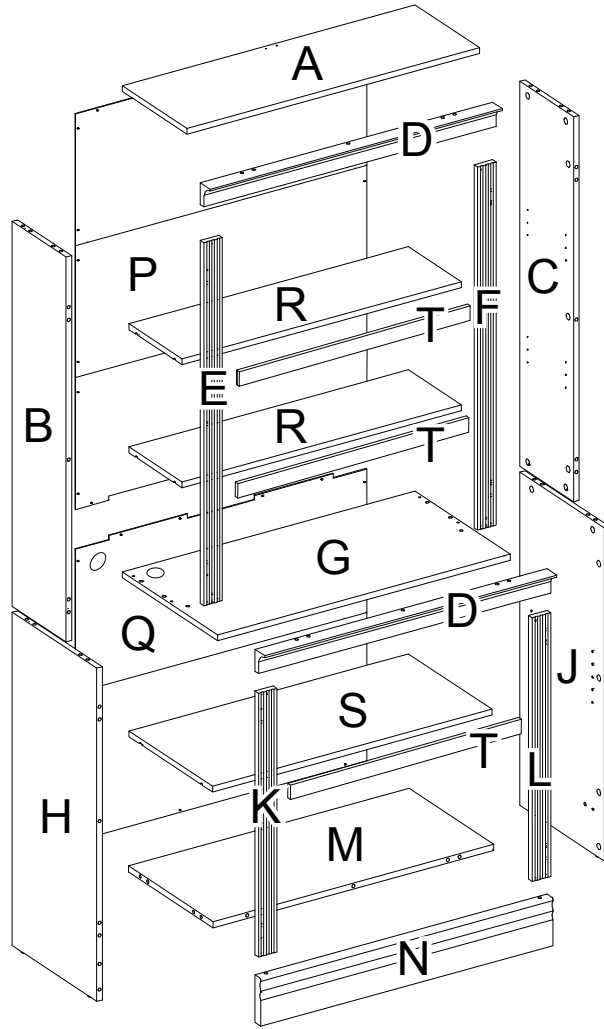

HARDWARE

AA x 48pcs



BB x 48pcs



CC x 42pcs



DD x 4pcs



EE x 12pcs



FF x 36pcs



GG x 12pcs



HH x 1pc



JJ x 1pc



KK x 1pc



LL x 24pcs



MM x 1pc



NN x 4pcs



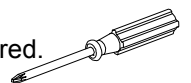

*NOTE: Extra hardware included.

*NOTE: Phillips screwdriver required.

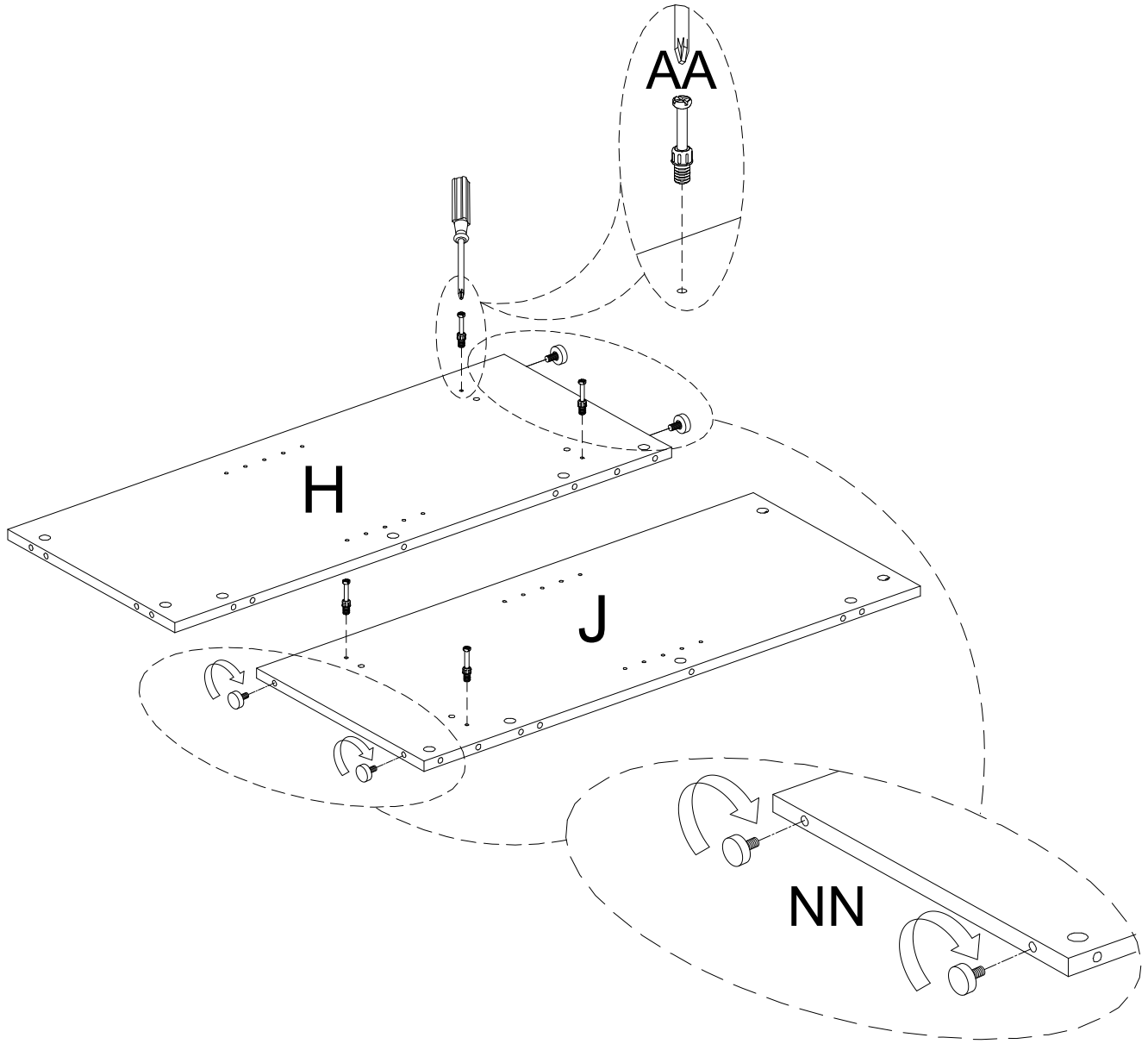

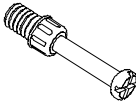

AA  x4

NN  x4

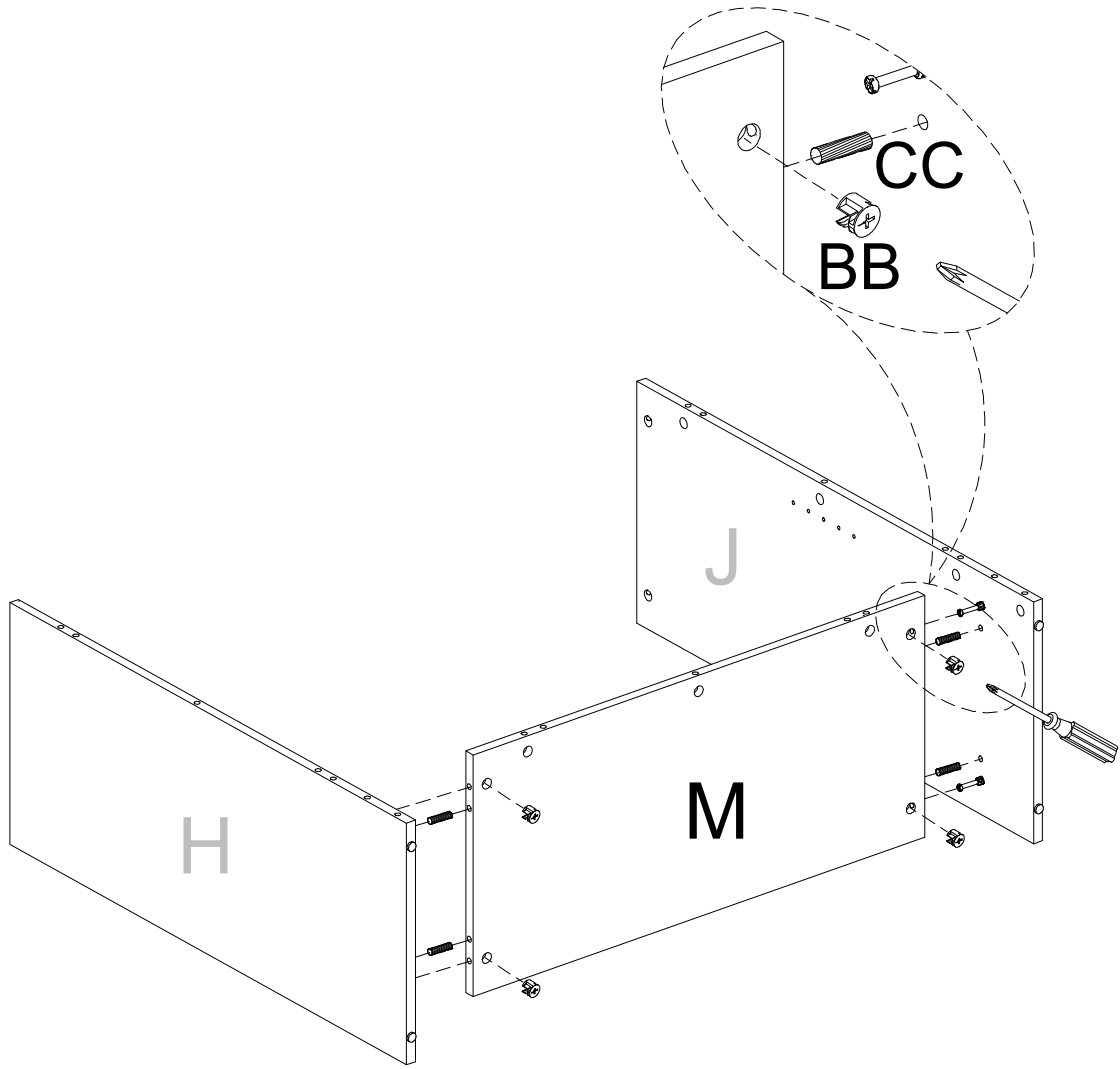

BB

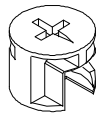

x4

CC

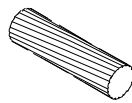

x4

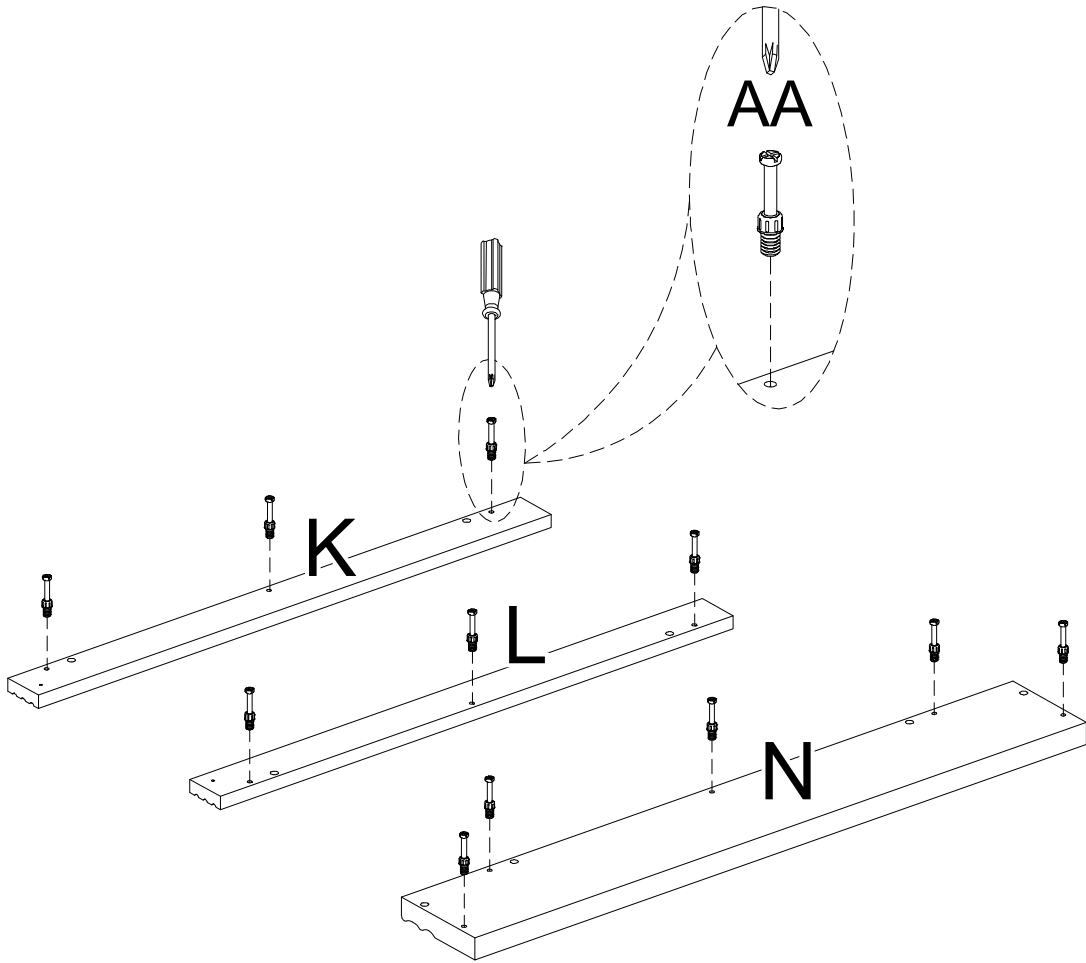

AA

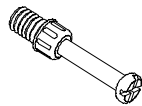

x11

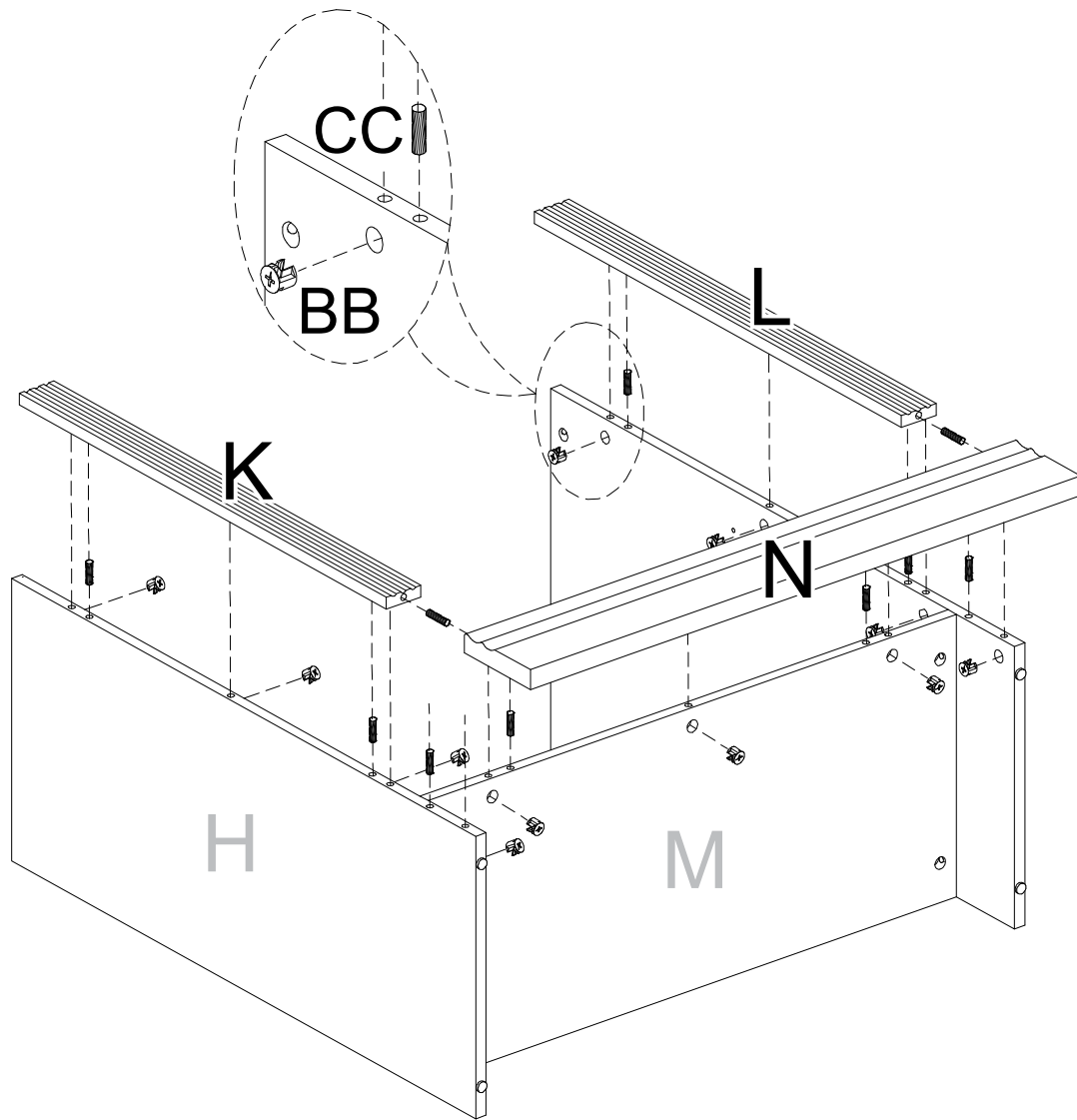

BB

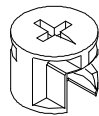

x11

CC

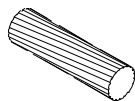

x10

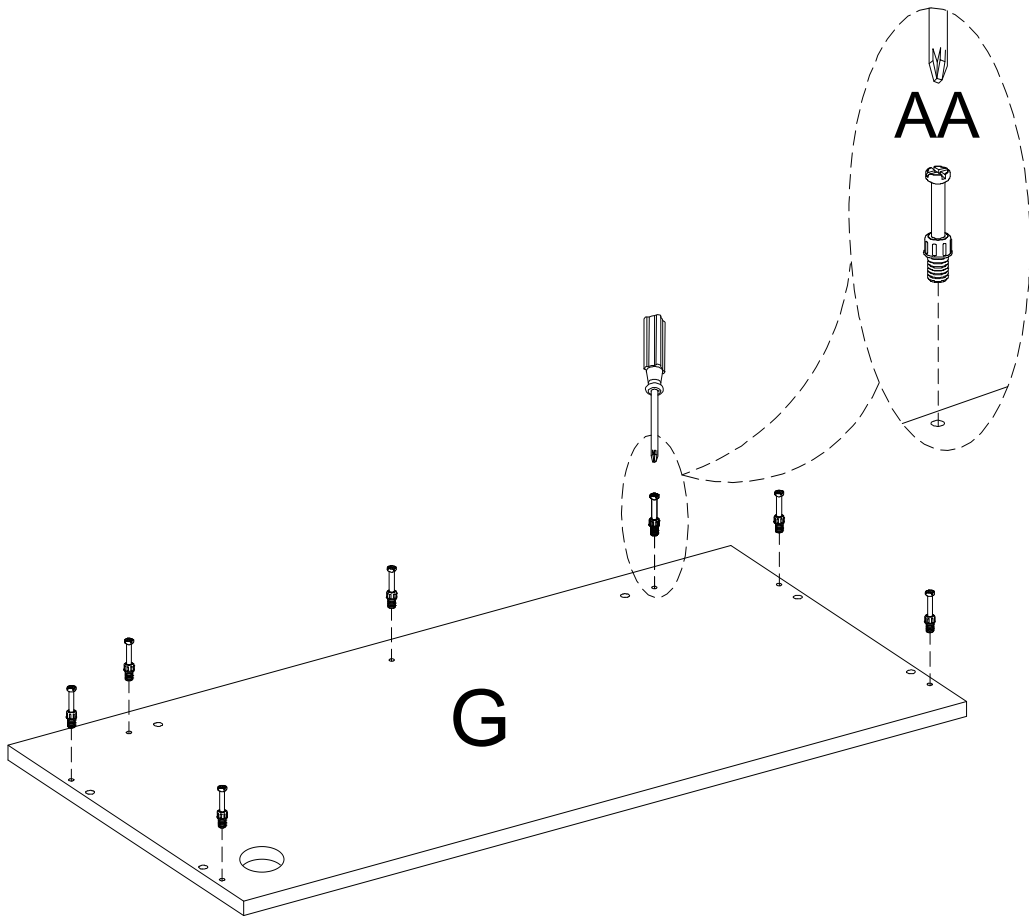

AA

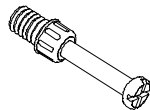

x7

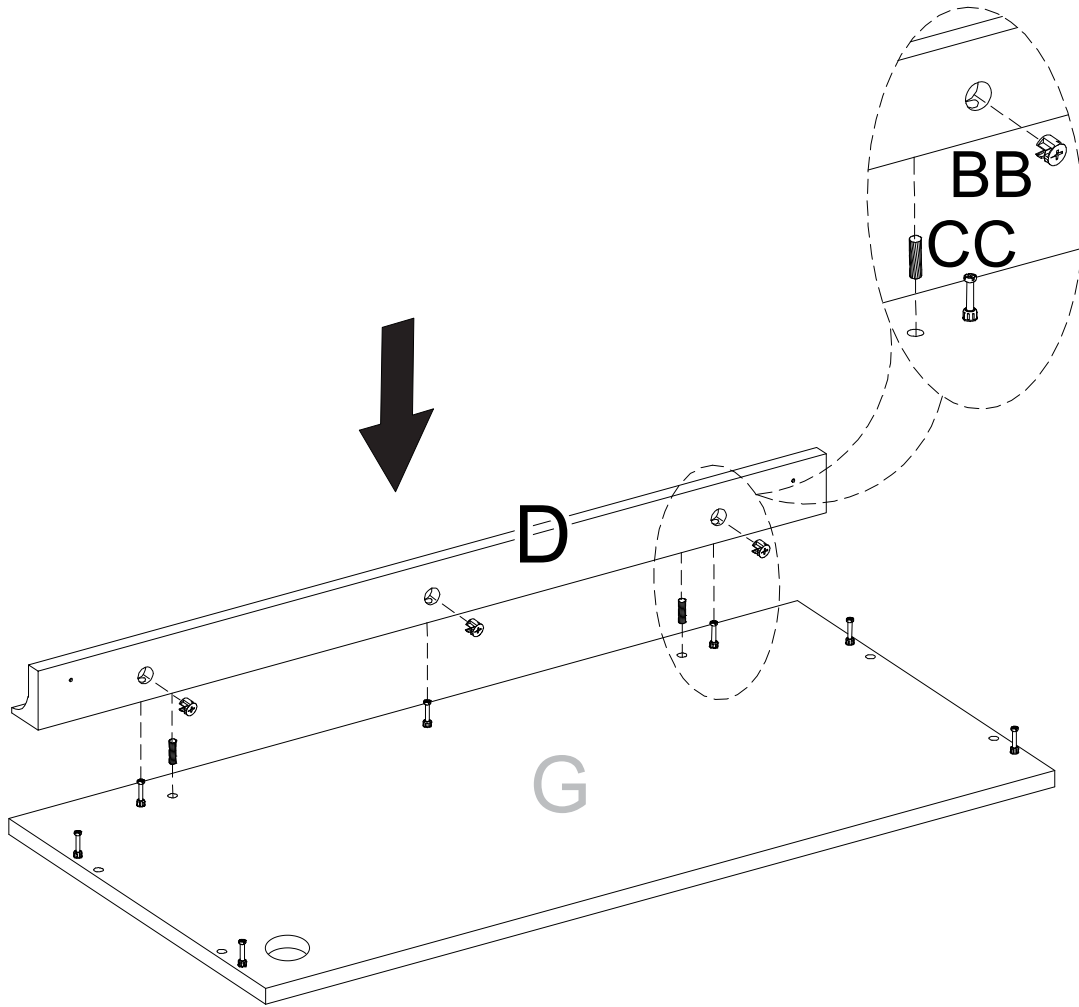

BB

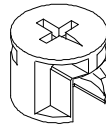

x3

CC

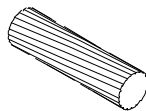

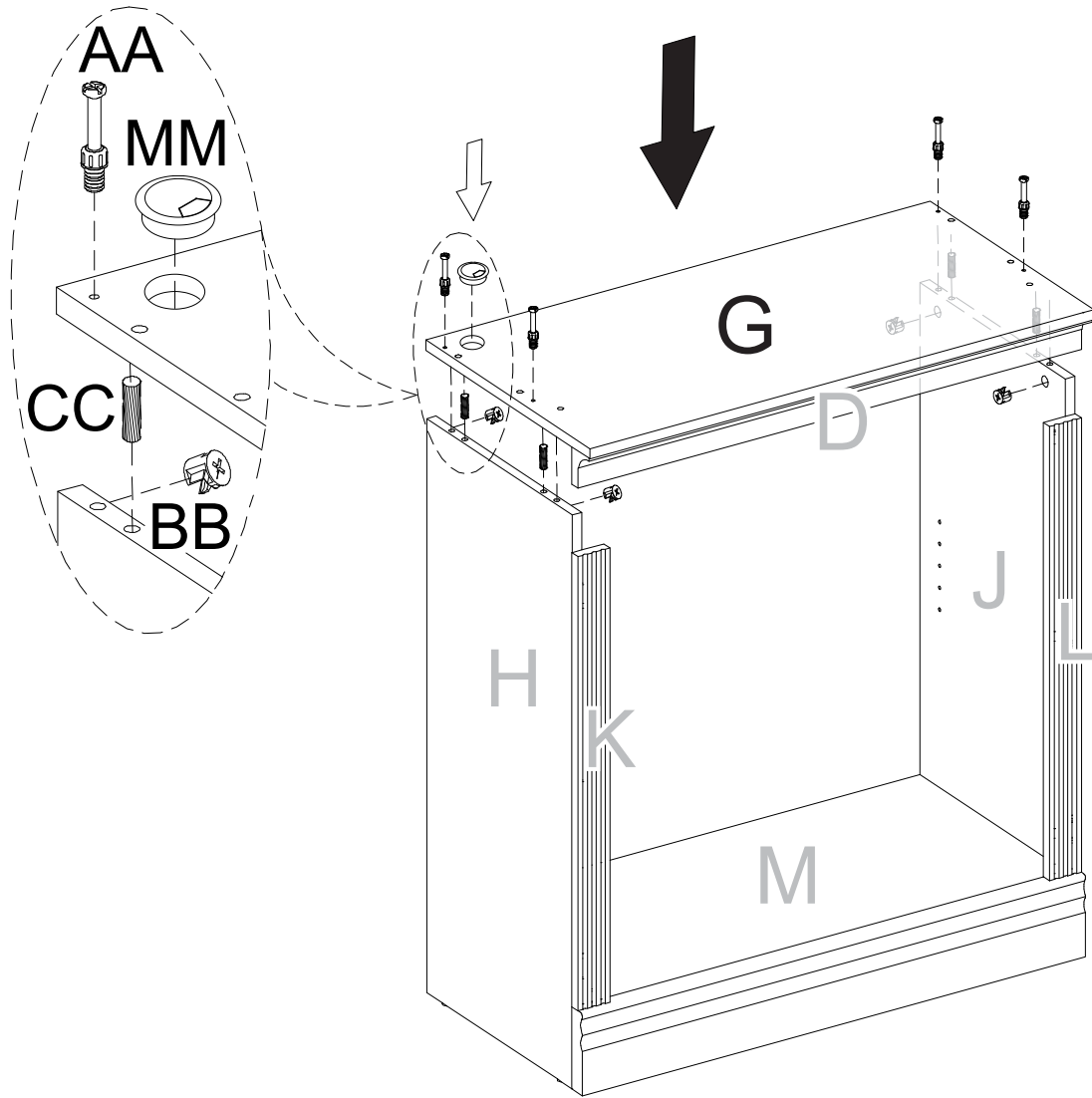

x2

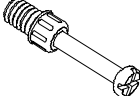

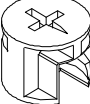
AA  x4

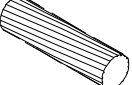
BB  x4

CC  x4

MM  x1

BACK VIEW

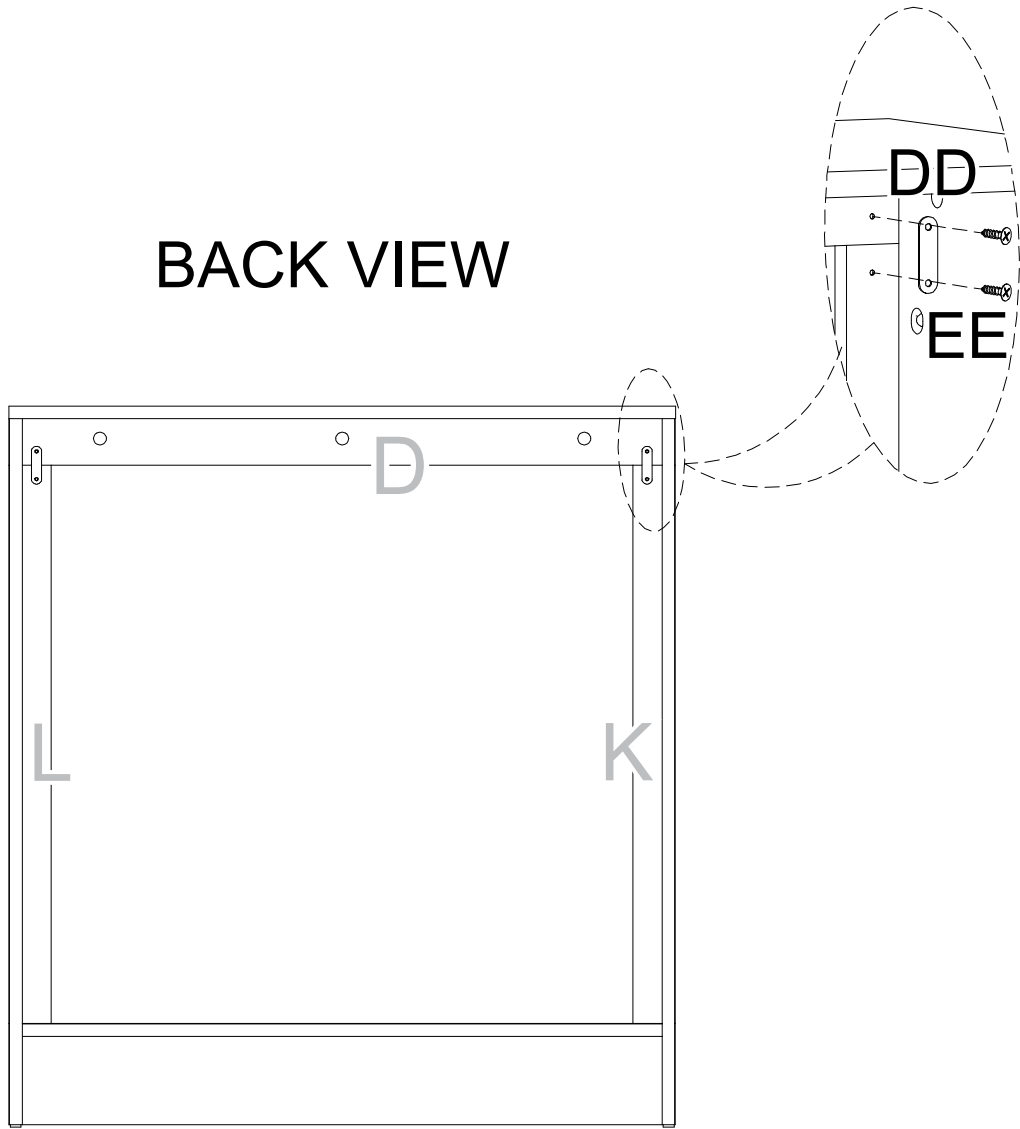

DD

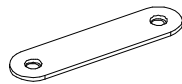

x2

EE

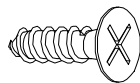

x4

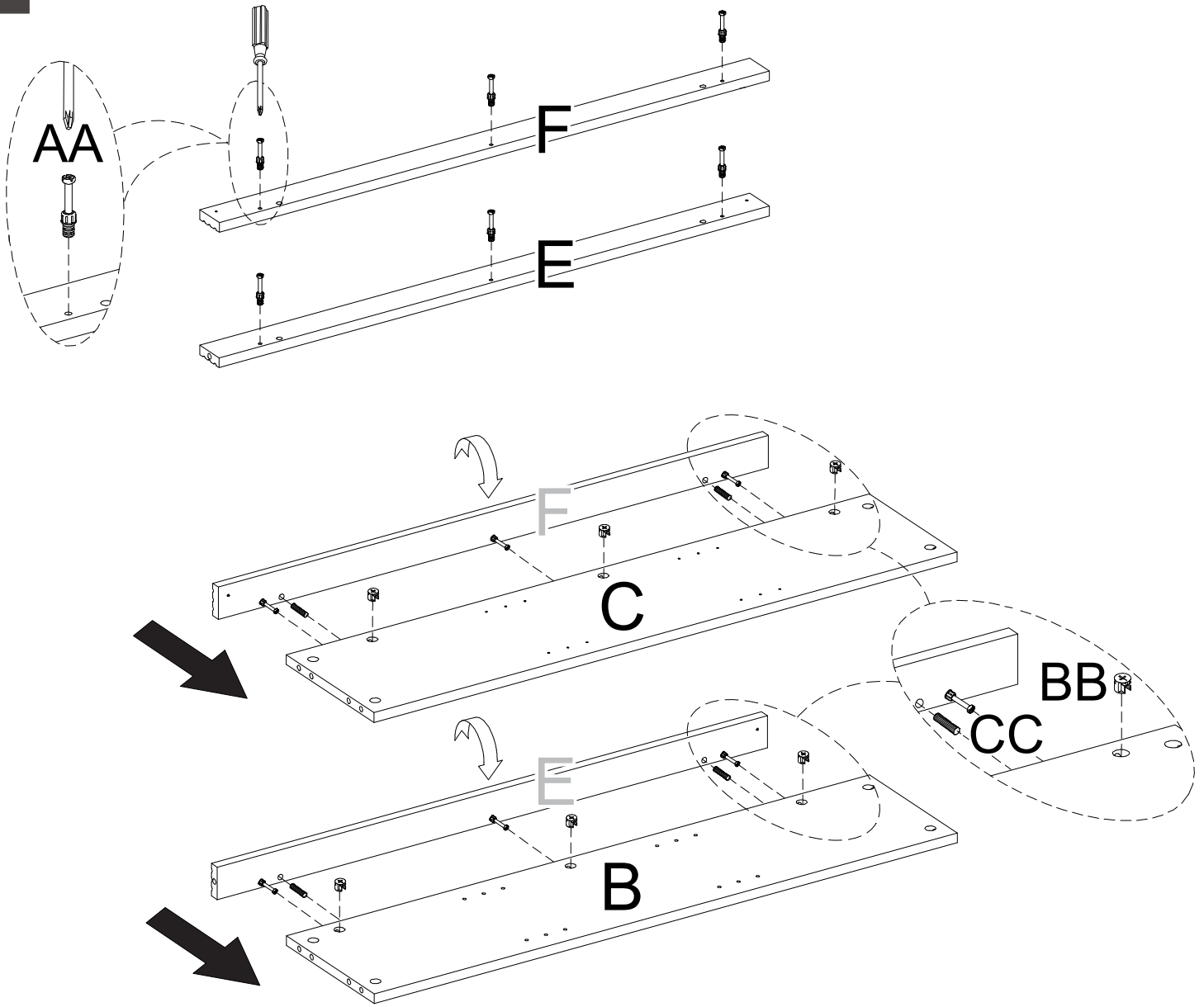

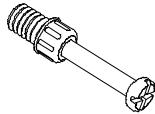
AA  x6

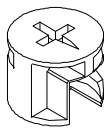
BB  x6

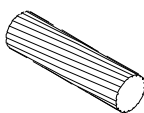
CC  x4

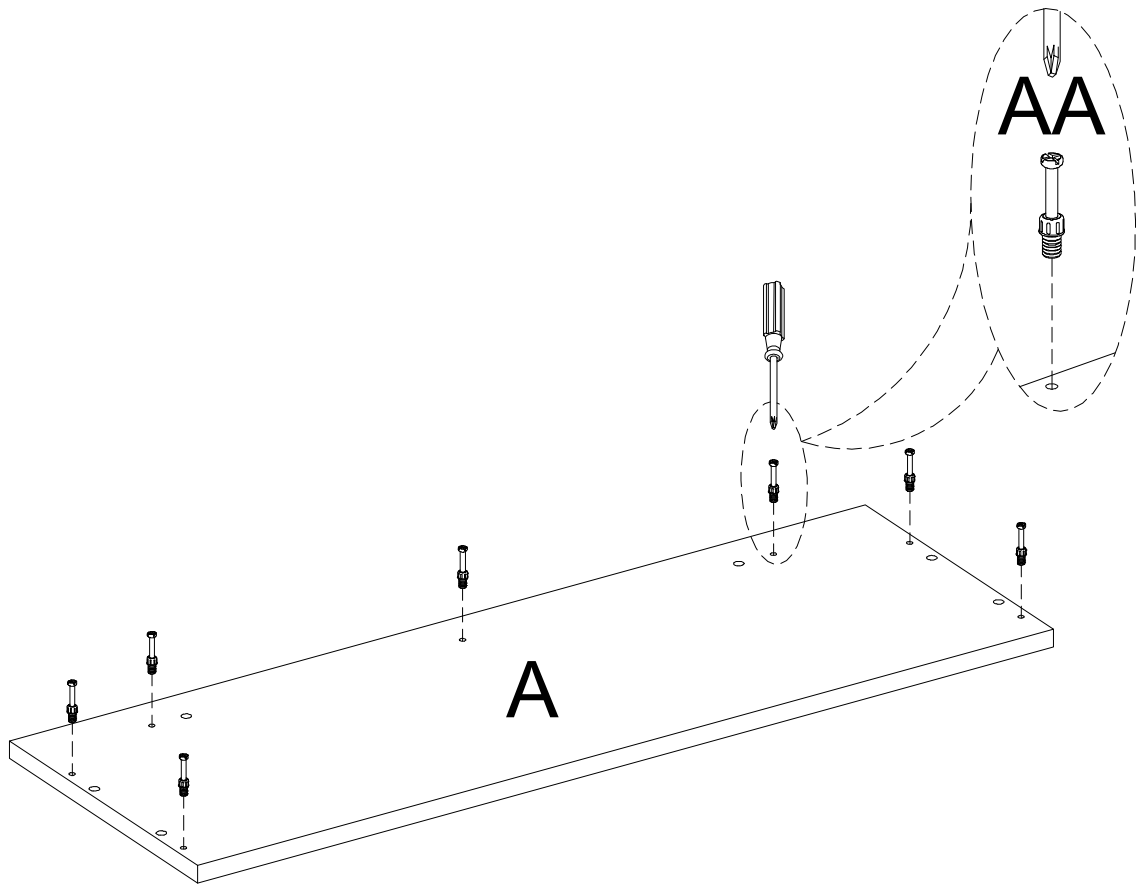

AA

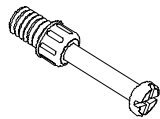

x7

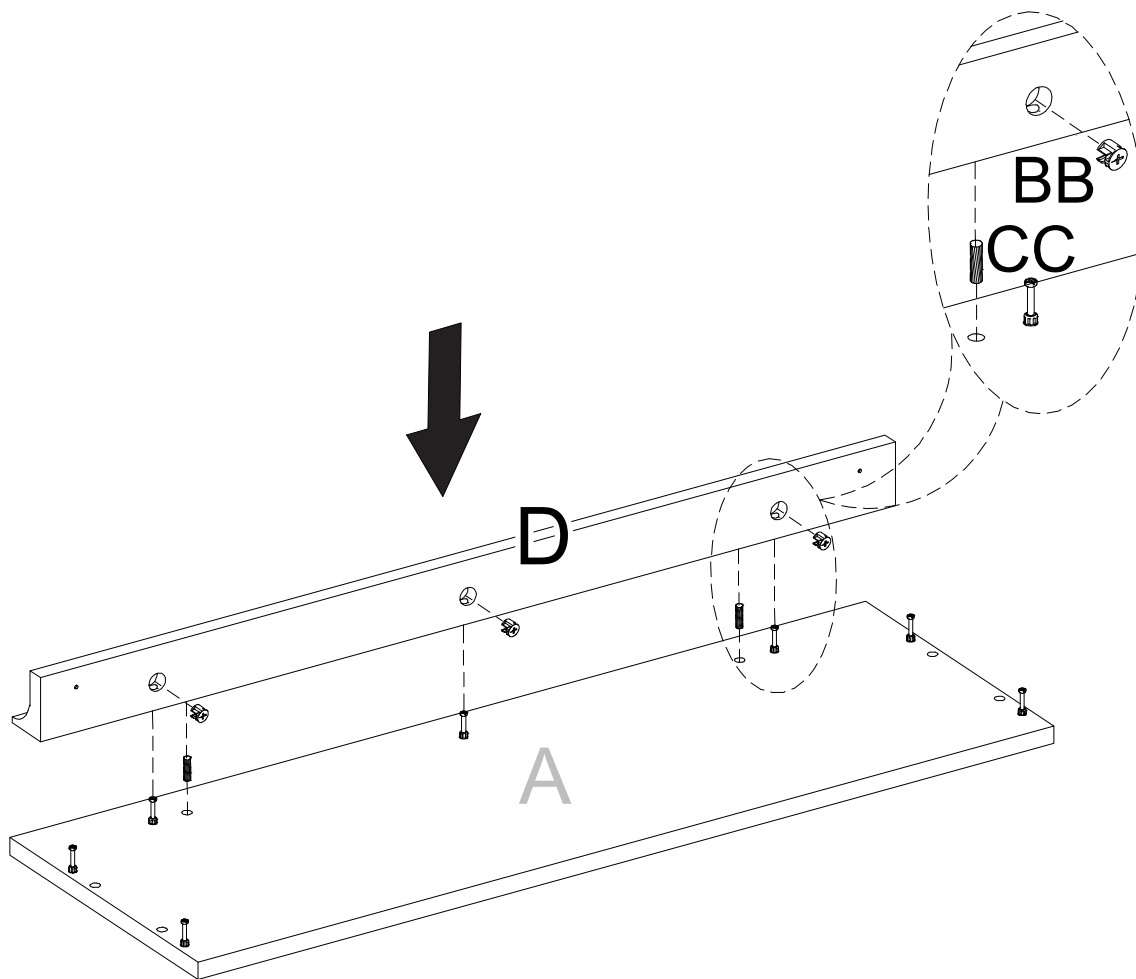

BB

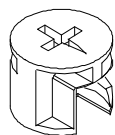

x3

CC

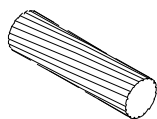

x2

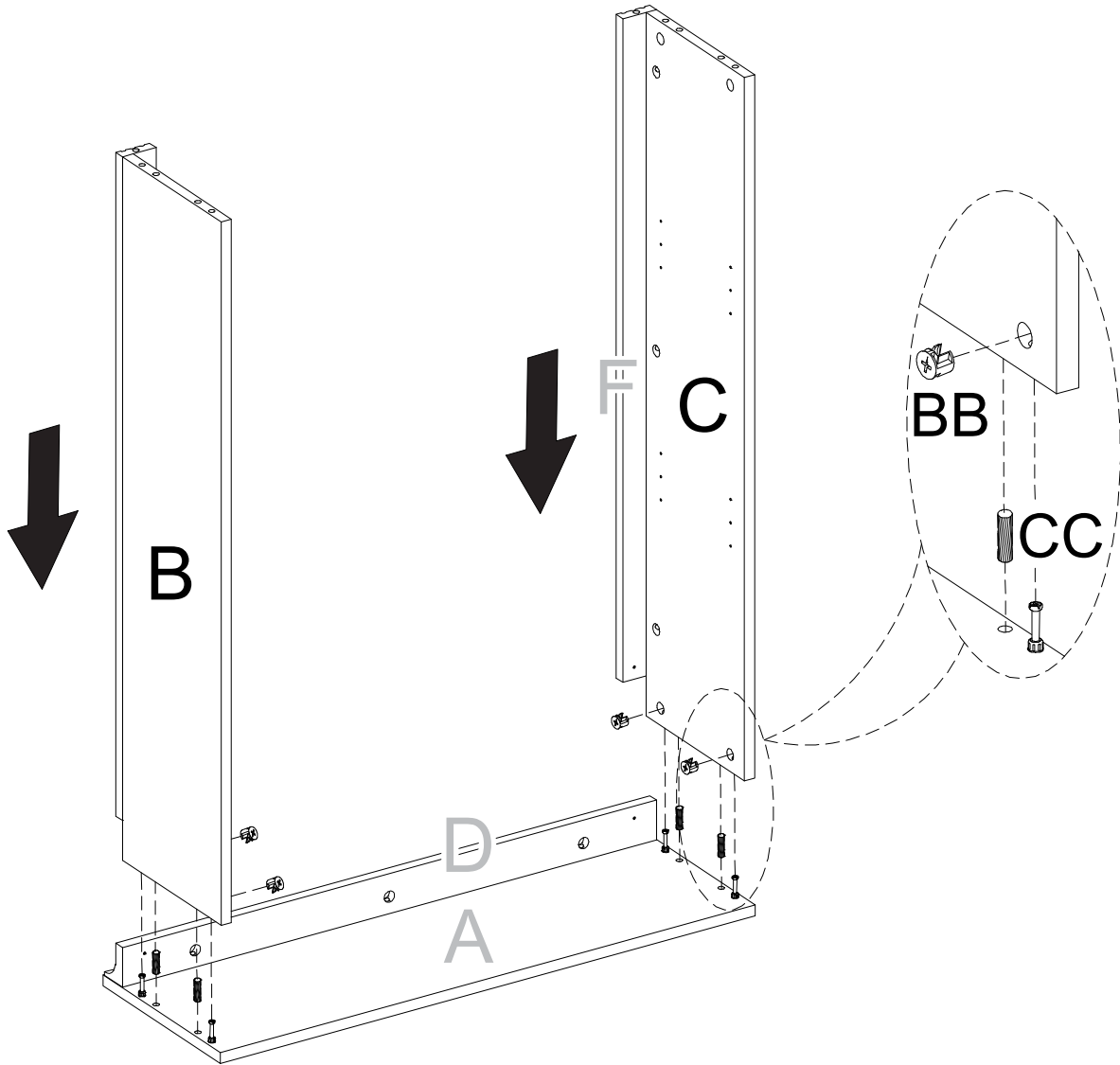

BB

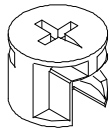

x4

CC

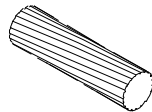

x4

BACK VIEW

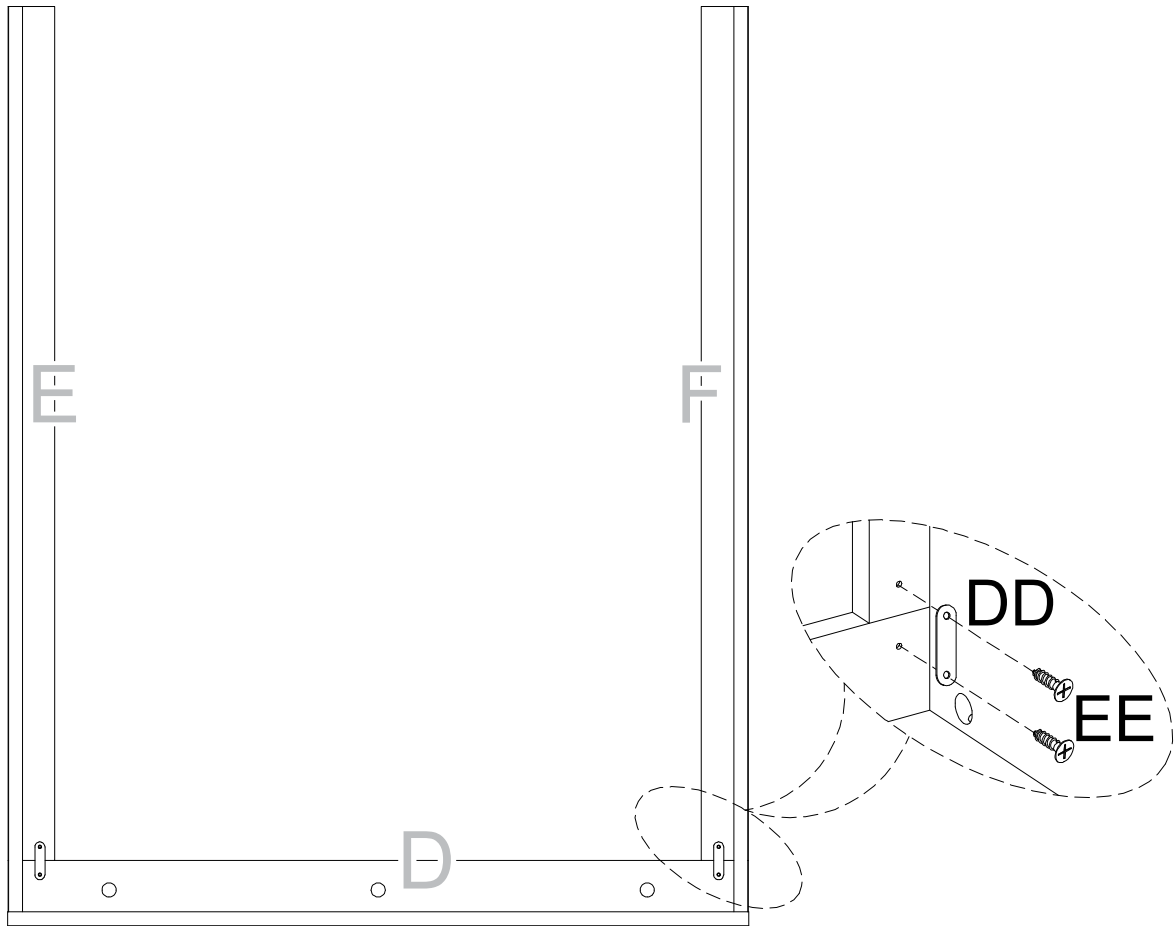

DD

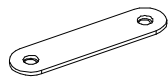

x2

EE

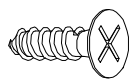

x4

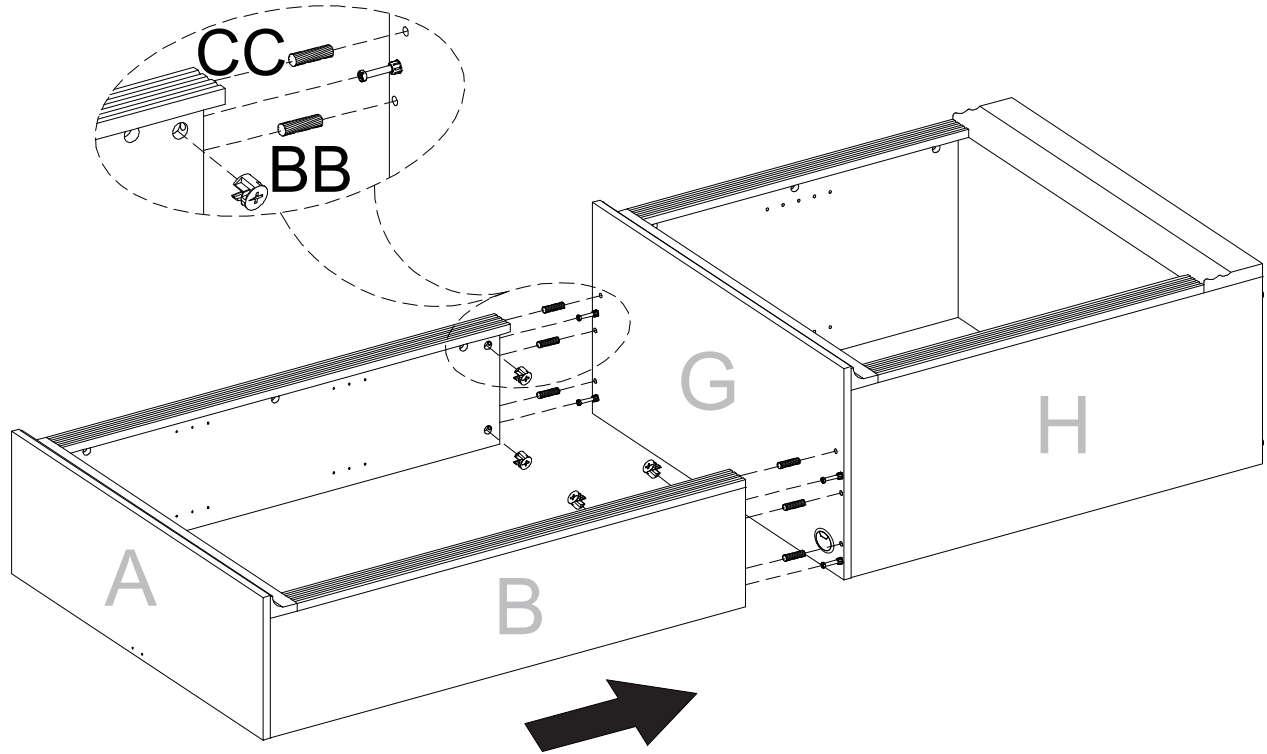
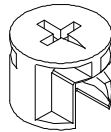
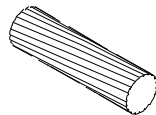
**BB****x4****CC****x6**

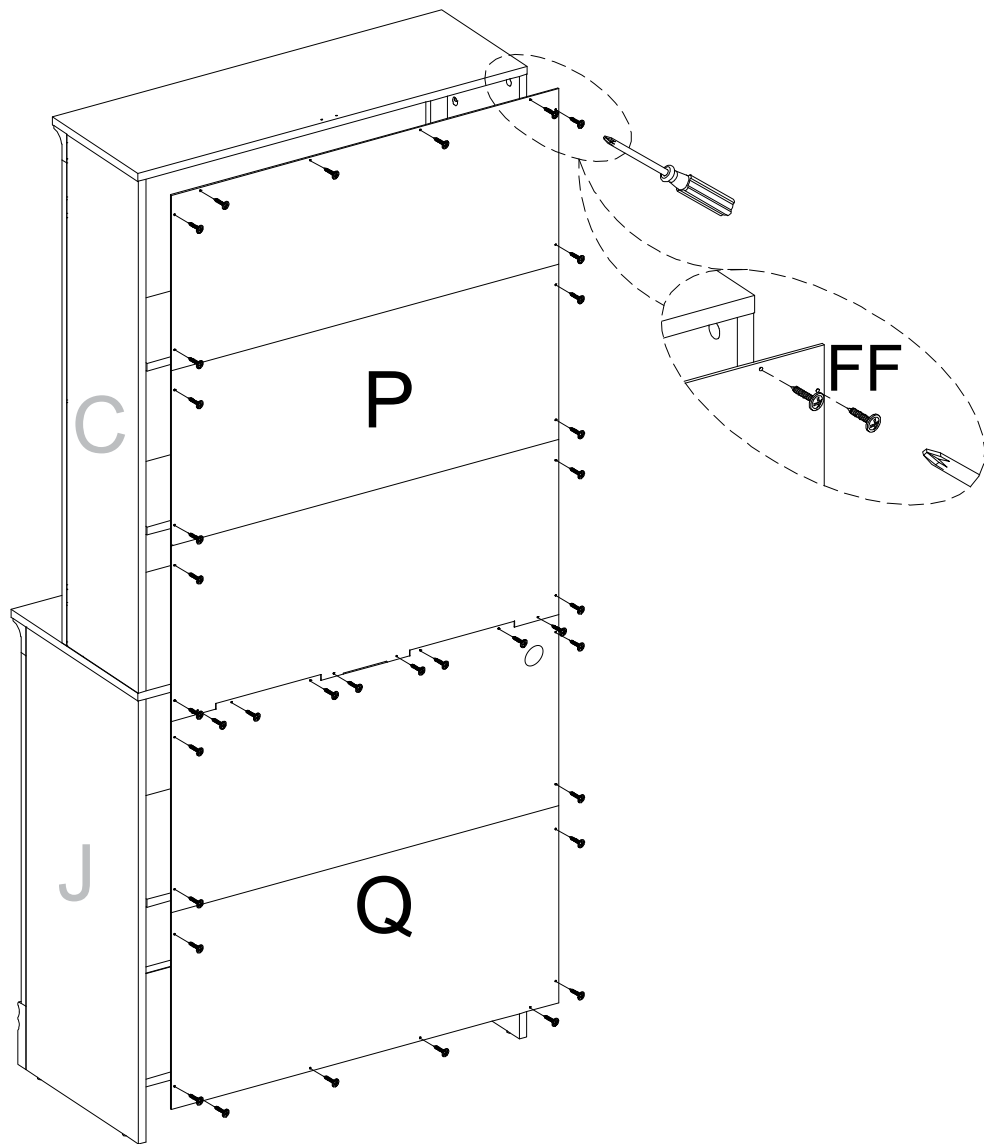

FF



x36

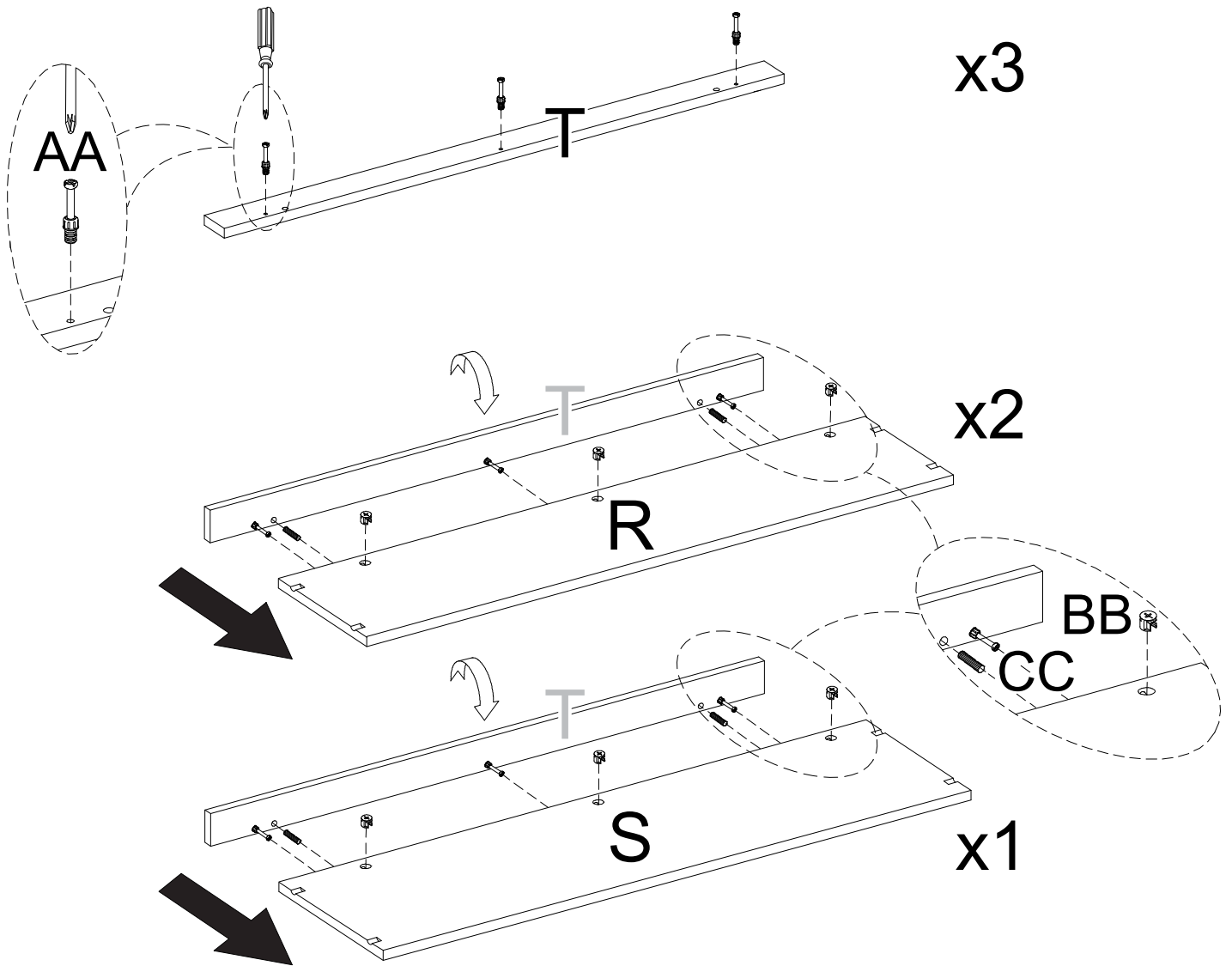

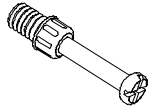
AA  x9

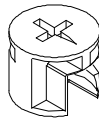
BB  x9

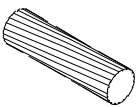
CC  x6

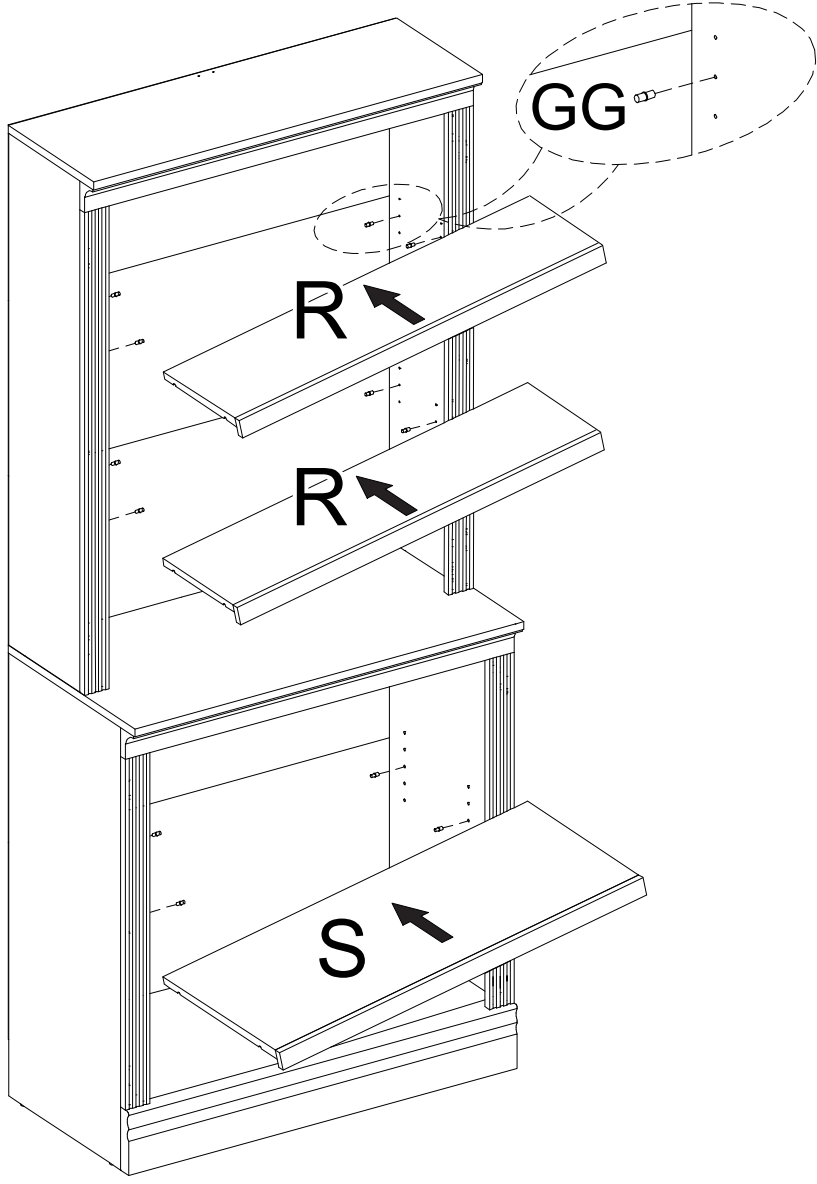

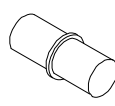
GG  **x12**

WALL

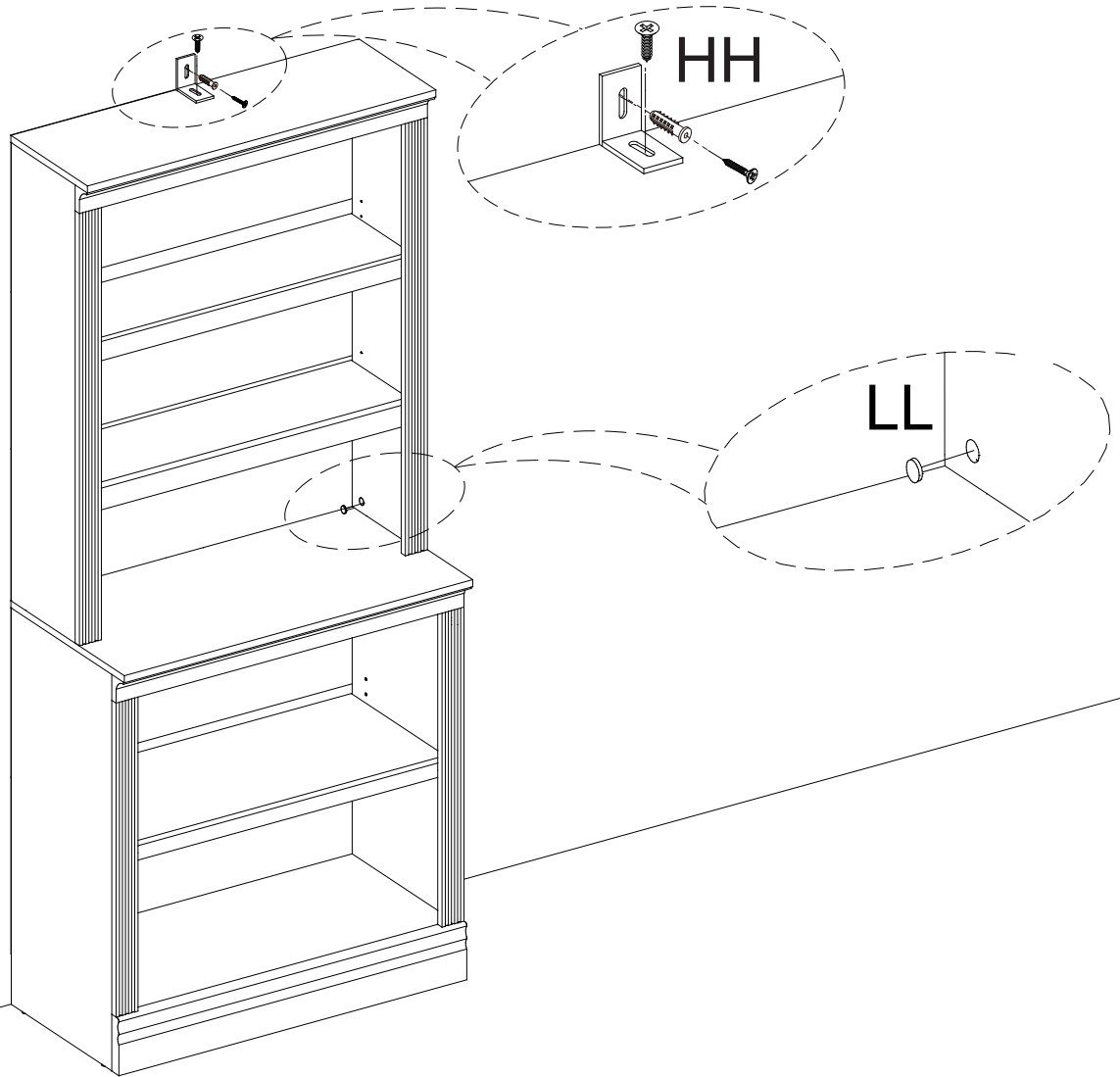

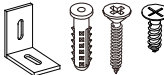
HH  x1

LL  x24

STYLE YOUR HOME WITH OUR
HALSTON MODULAR BOOKCASE COLLECTION

MIX & MATCH STYLES & COLORS
CREAM • OAK • DARK CHERRY

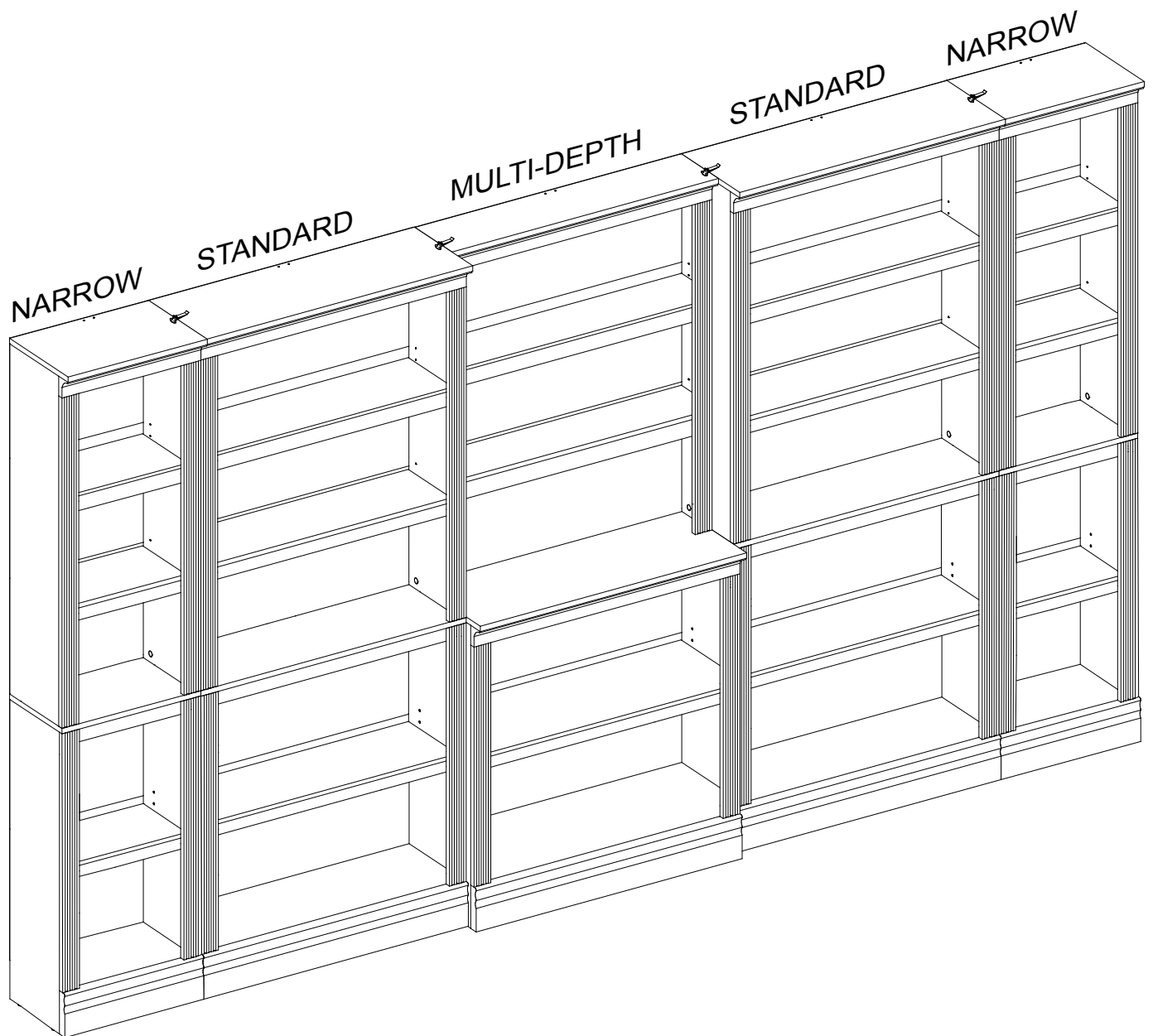

HOW TO ATTACH ON NEXT PAGE

ATTACHING THE BOOKCASES

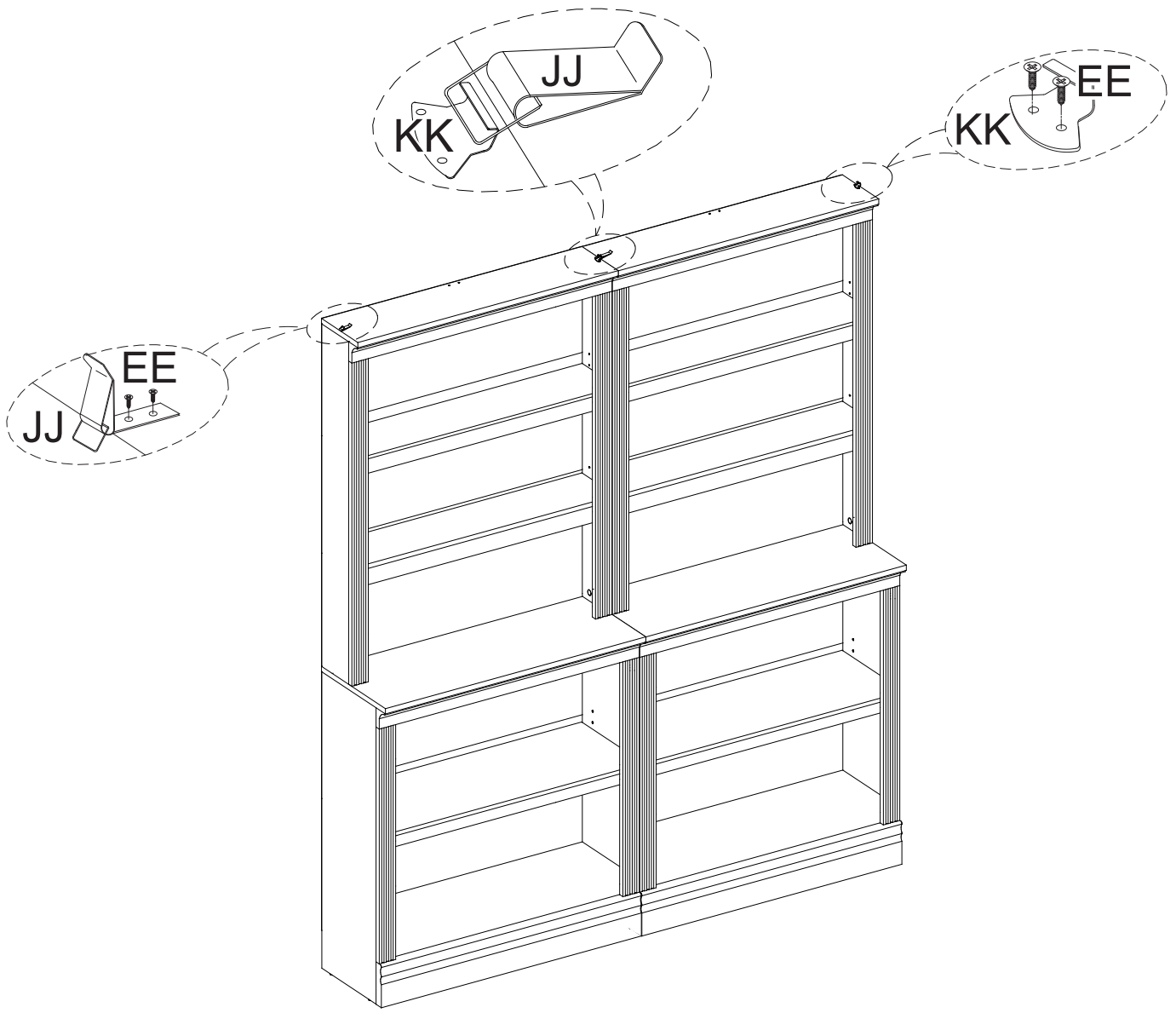

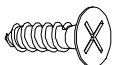
EE  **x4**

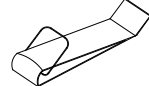
JJ  **x1**

KK  **x1**