

ASSEMBLY INSTRUCTION

15'x 15' STEEL DOUBLE ROOF GAZEBO

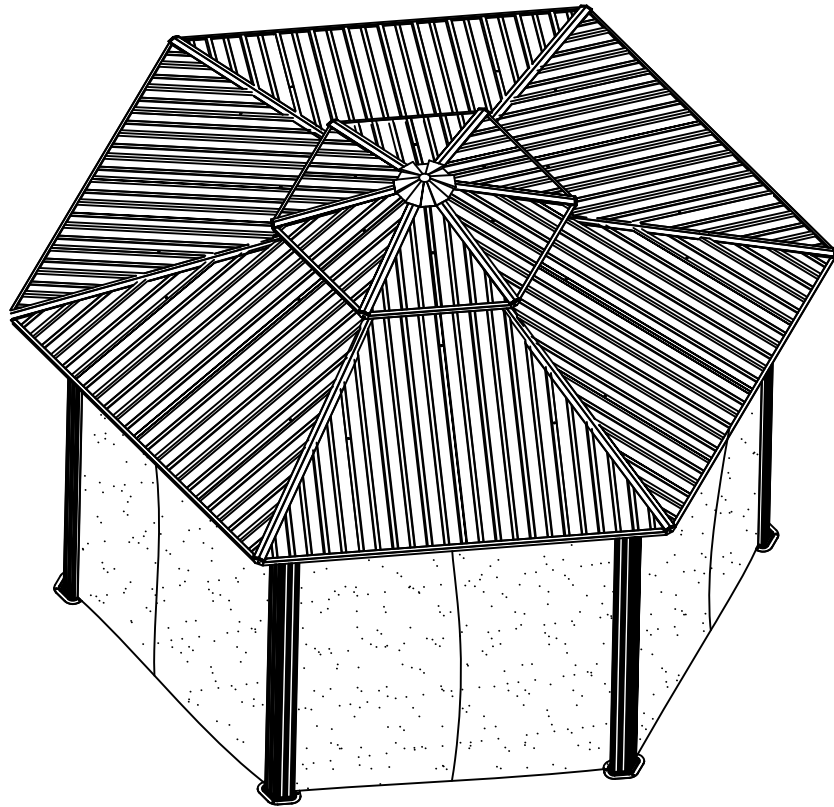

MONDAWE

Website: www.mondawe.com
Customer Service: service@mondawe.com
Phone: 888-328-5111

Important Safety Instructions



Warning! To reduce the risk of serious injury, read the following safety instructions before assembling and using the gazebo.

Please check with your local governing authority/local municipal codes regarding installation of structures before assembly.

Caution! Proper placement of your gazebo is essential.

Do not place the product underneath electrical lines.

Keep children away during assembly.

This product contains small parts which can be swallowed by children.

Keep fingers away from the places where they can be pinched or trapped.

Do not attempt to assemble the gazebo if any parts are missing.

- This product is intended for domestic outdoor use only.
- The product should be placed on flat, horizontal ground.
- Ensure enough clearance around the product. Before assembling the product, find level ground not less than 6' (1.8 m) away from any structures or obstructions, such as fences, garages, houses, overhanging branches, laundry lines, or electrical wires.
- This gazebo is not to be regarded as part of a building/house structure. The gazebo is to be anchored onto the ground for added safety. Do not assemble the gazebo onto soil/earth ground. It is best advisable to have the gazebo built onto a wooden deck or concrete ground for stability. If it is to be built onto a wooden deck/ground, do ensure that the wooden deck/ground has a strong foundation. It is advisable to use appropriate floor plugs (not provided) to anchor the gazebo onto the wooden/concrete ground.
- Some structures may require two or more people to install safely. Check for underground utilities before digging or driving stakes into the ground.
- During installation, follow all safety warnings provided with your tools, and use safety glasses.
- In case you set up more than one gazebo, keep a minimum distance of 10' (3 m) between the gazebos.
- Any assembly or maintenance of the product must be carried out by adults only.
- Arrange necessary manpower when assembling or moving the product.
- Some parts may contain sharp edges. Wear protective gloves if necessary.
- Keep children and pets away while setting up the gazebo.
- Check all nuts and bolts periodically to ensure bolts/nuts are tightened.
- Repairing and replacing parts should be done by a qualified technician.
- This gazebo is intended for decorative and sunshade purposes only, and it is not designed to withstand harsh weather, including high winds, rain, and snow.
- Do not light any fires inside or near the product!
- Stay calm if fire breaks out. Search for the nearest exit. Do not return to the gazebo before firemen allow you to do so.

- Do not hang heavy weights on the roof frame.
- Do not climb onto the roof of the gazebo. Falling off the gazebo can result in serious injury.
- Retain the original packaging to store the gazebo.

IMPORTANT:

- Please read and understand this manual before any assembly. Before beginning assembly of product, make sure all parts are present. Compare parts with packaging contents list.
- If any part is missing, or if you have any questions, contact the service Centre at 888-328-5111.
- Place all parts from the box in a cleared area and position them on the floor in front of you.
- Remove all packing materials and place them back into the box. Do not dispose of the packing materials until assembly is complete.
- Read each step carefully before beginning any assembly and make sure you understand each step.
- Needed for assembly: (The following tools are not included)

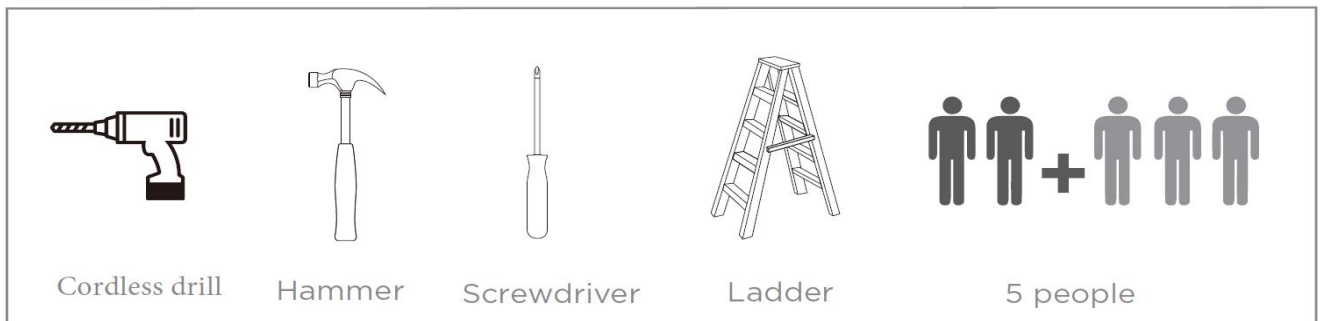

This identifies information that requires special attention. Improper assembly could lead to an unsafe or dangerous condition.



Use Level

Check that set or assembly is properly level before proceeding.

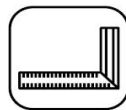

Square Assembly

Check that assembly is square before tightening bolts.

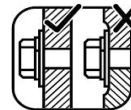















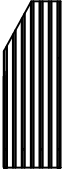

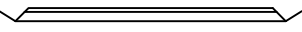

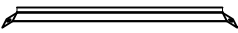











Tighten Bolts

Do not overtorque mounting bolts. Over-tightening may cause the wood to crack creating splinters and other structural damage.









Measure Distance

MOA070-1

A		6	N2		6
B		6			
E		6	N3		6
G1		6			
G2		6	O1		6
G3		6			
H		6	O2		6
H1		6			
J1		6	O3		6
K		1			
K1		1	N4		6
L		6			
M1		6	O4		6
M2		12			
M3		12	Q		36
M5		72	R		72
M7		1	R1		24
N1		6	X	 M6*15	84
			X1	 M6*10	48

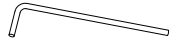
MOA070-1

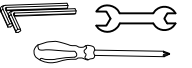
X2	 5*10	18	Z1		1
X3	 M6*25	66	Z2		6
X4	 M6*30	6	Z3		12
X5	 M6*50	6			1

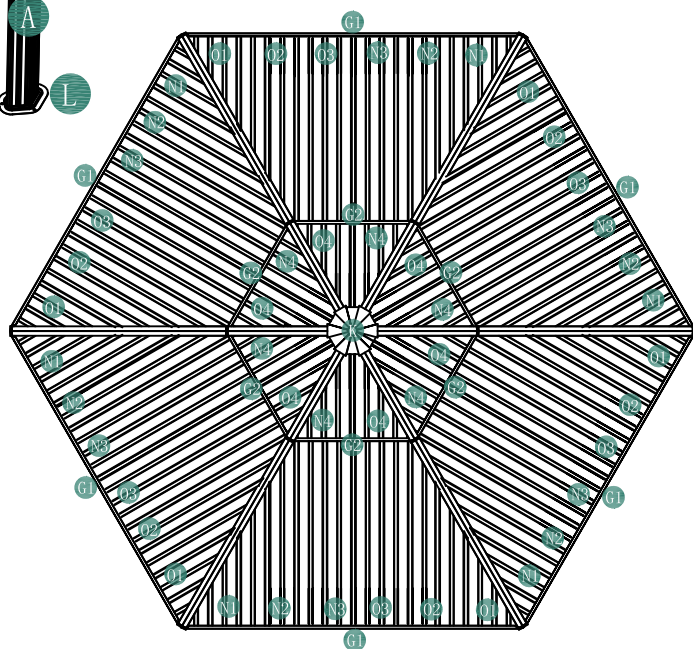
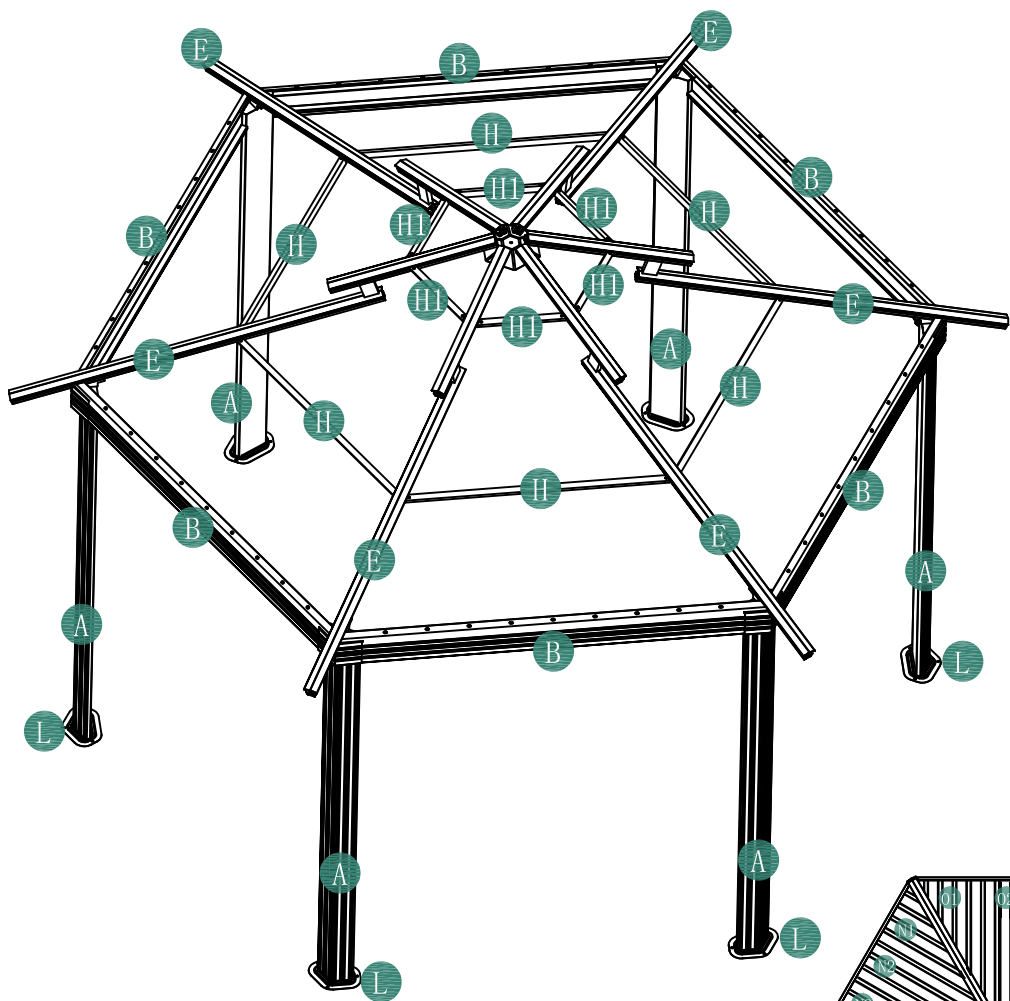

step1

Connect Stake Plate(L) to bottom of Post(A) by using Bolt (X)

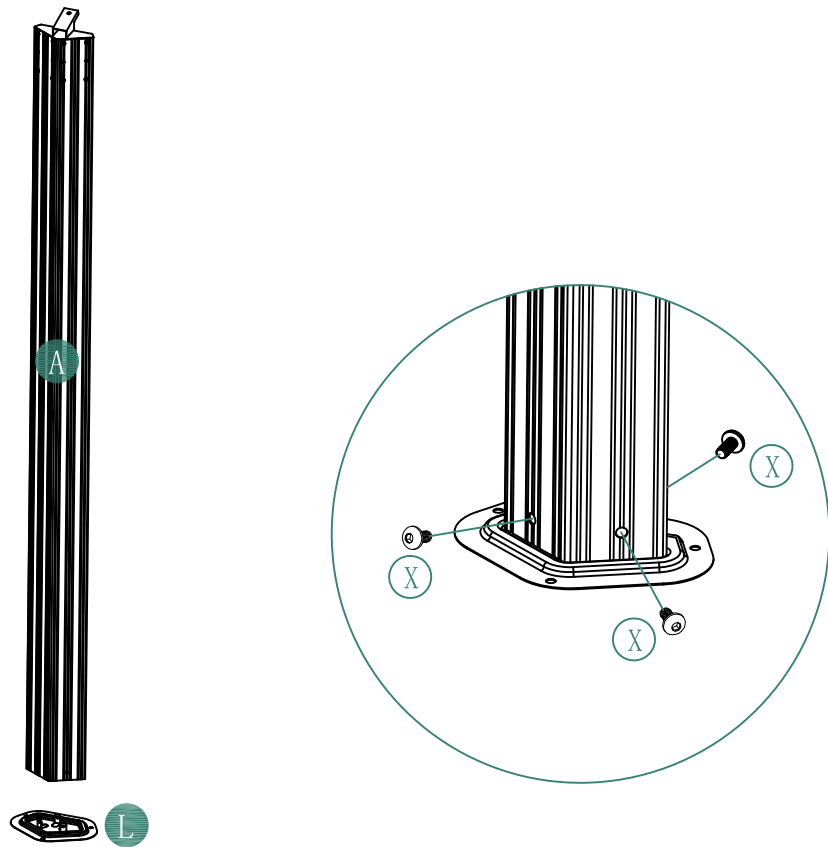

step2

Attach Long Side Beam (B) to Post (A), fix by using Bolt (X1).

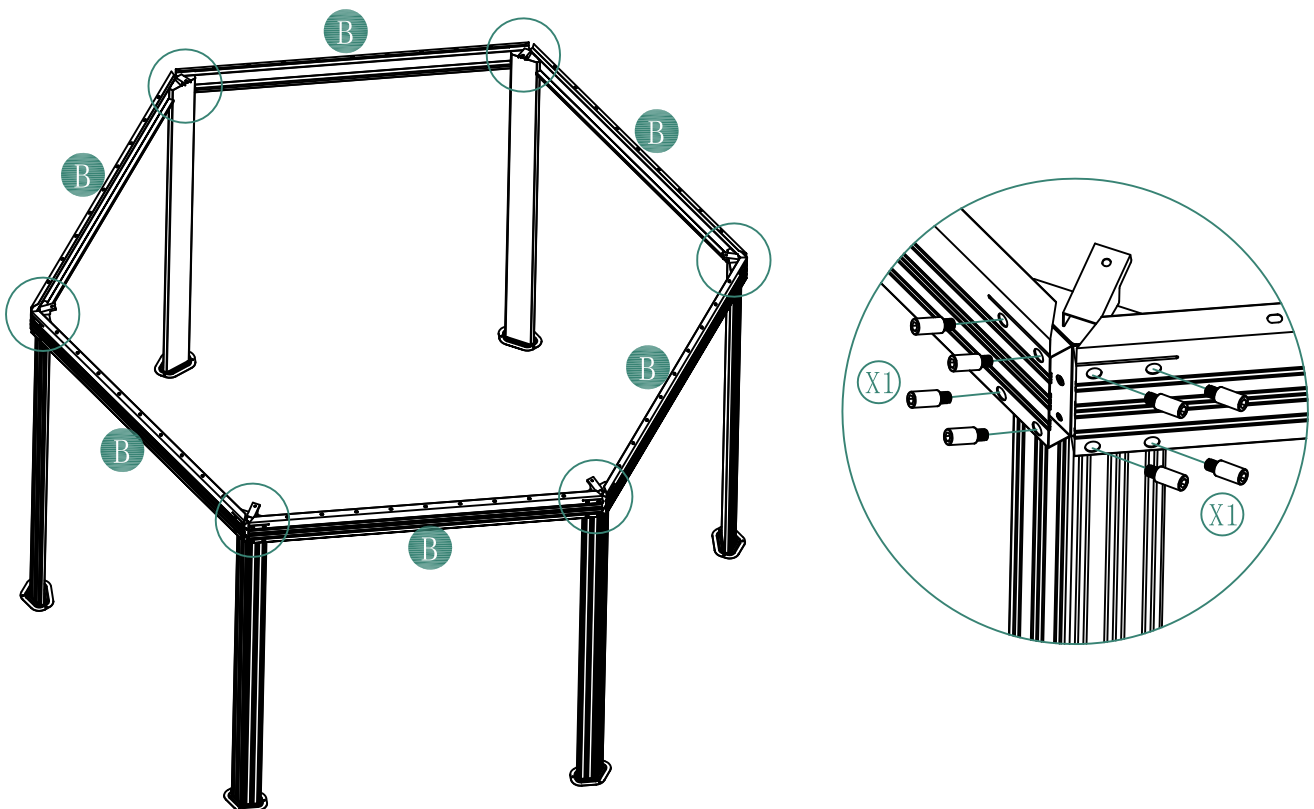

step3

Attach Corner Sleeve (J1) to assembled Beam(B), fasten by using Bolt (X2).

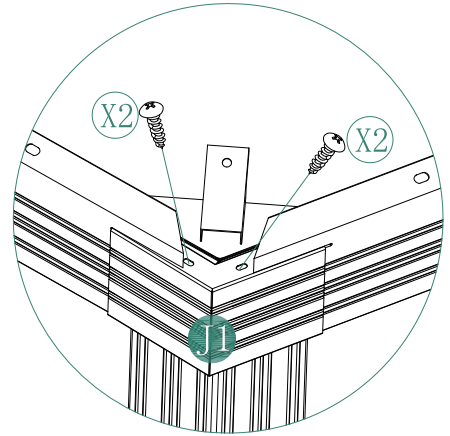
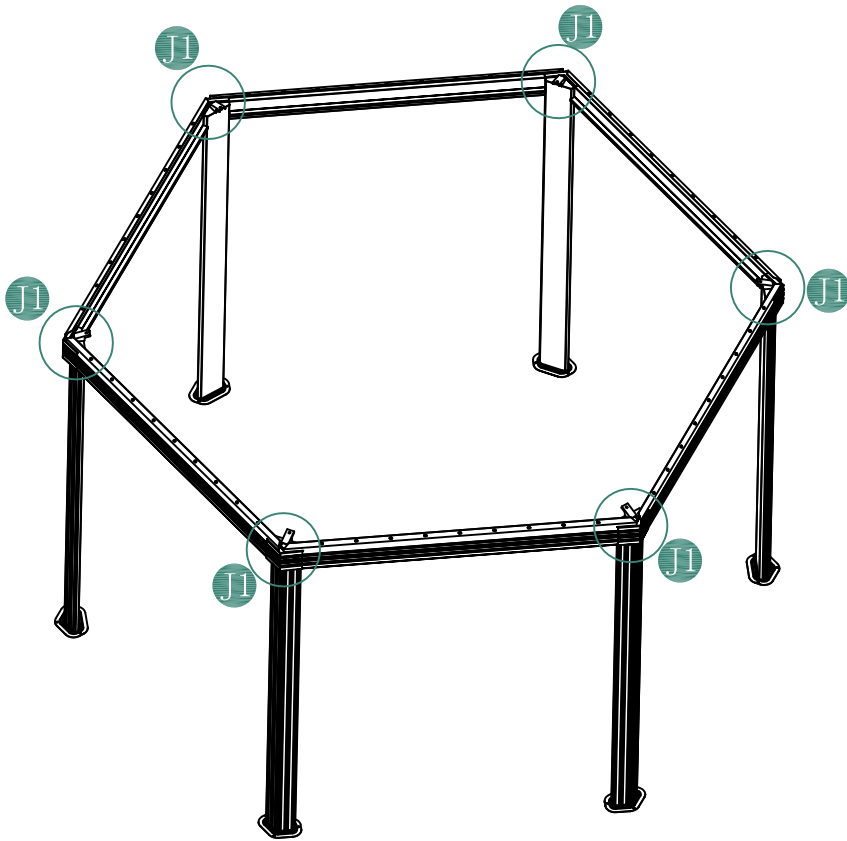

step4

1-Slide 6 Hooks(Q) into long sides beams(B).
2-Attach part M1 to inside beams(B) fix by using Bolt (X2)

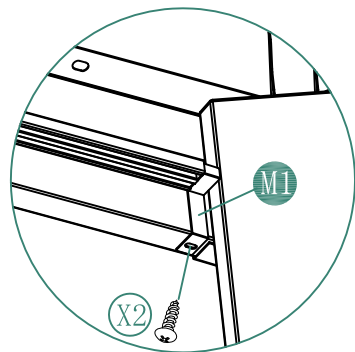
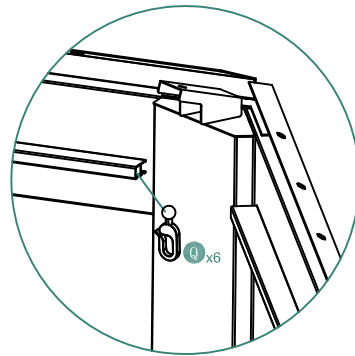

step5

- 1-Attach the long roof ribs (E) to the beams(B) by using Bolt (X)
- 2-Attach the top of long roof ribs (E) to the Roof Top Brace(K1)fix by using Bolt (X)

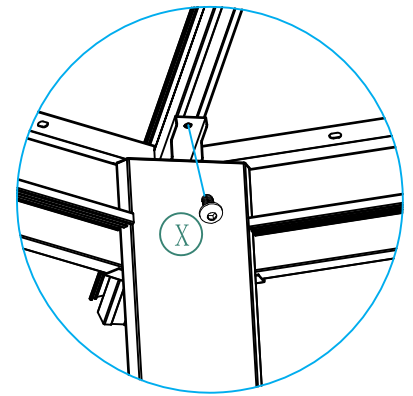
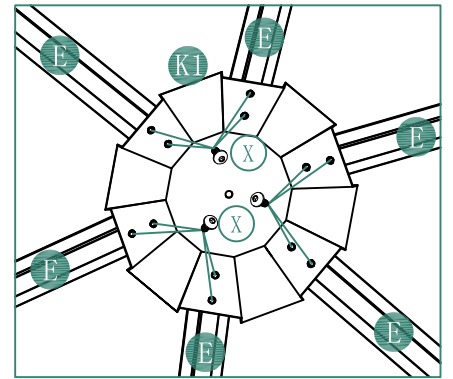
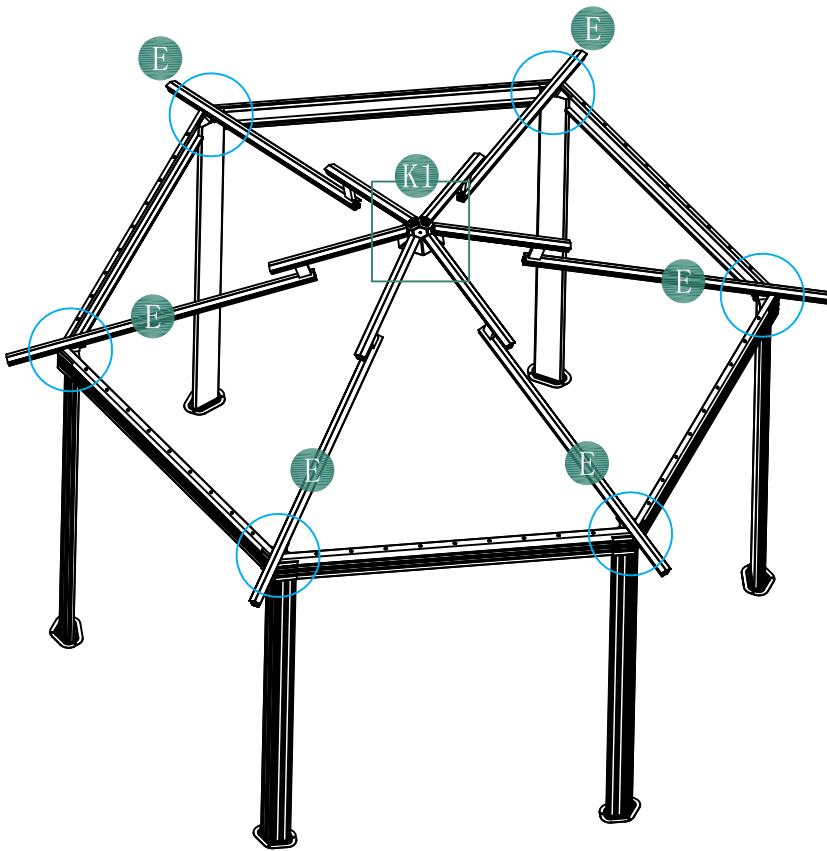

step6

Attach the 2 roof supports(H1) to connectors(M3), fix by using Bolt (X)

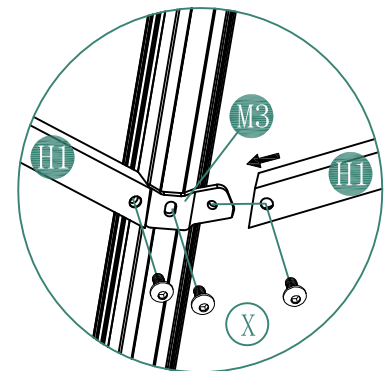
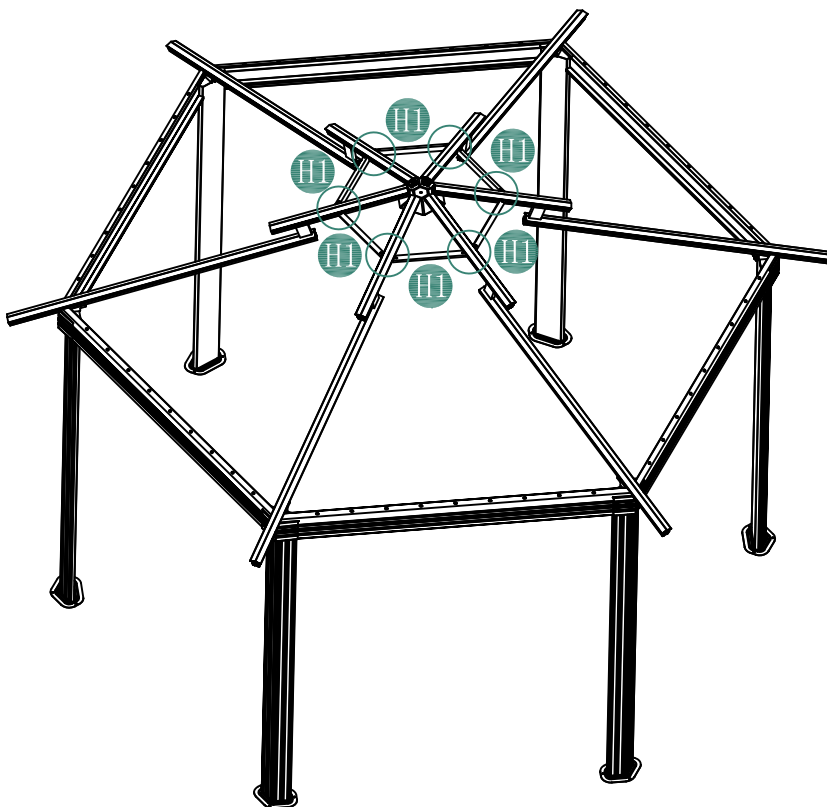

step7

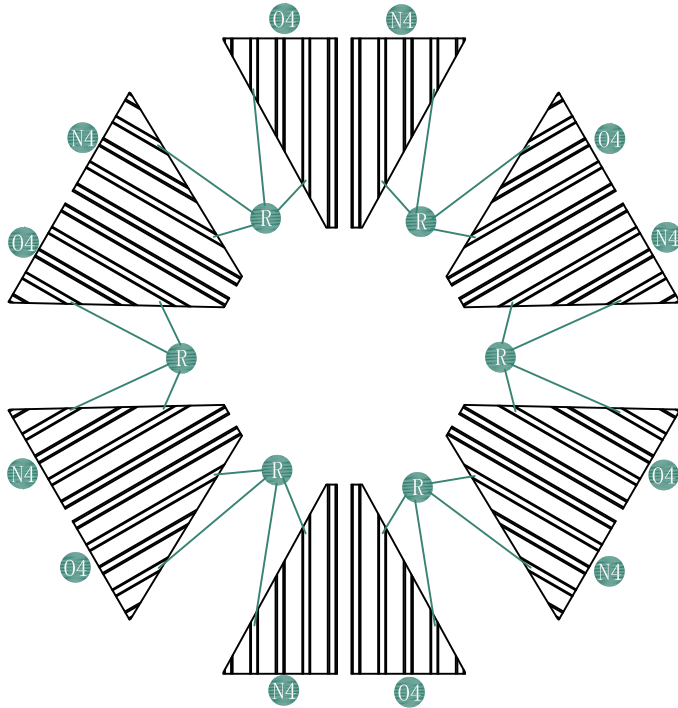

attach the clips(R) as shown in the diagram

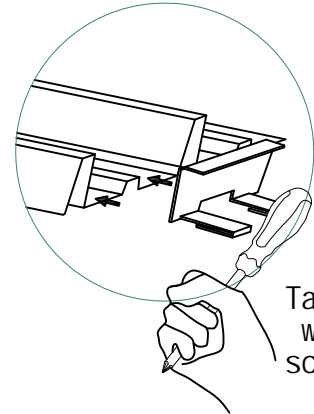

Tap lightly with the screwdriver

step8

Install the Roof Plates (O4 and N4) on the Short Sides of the Gazebo

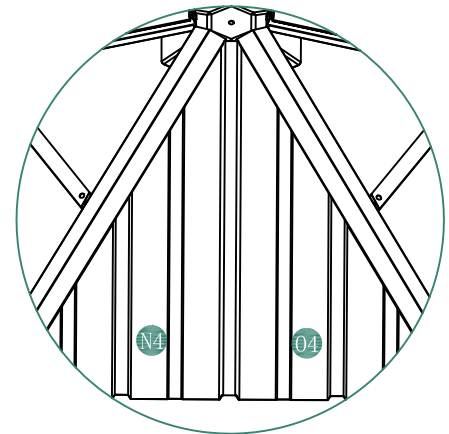
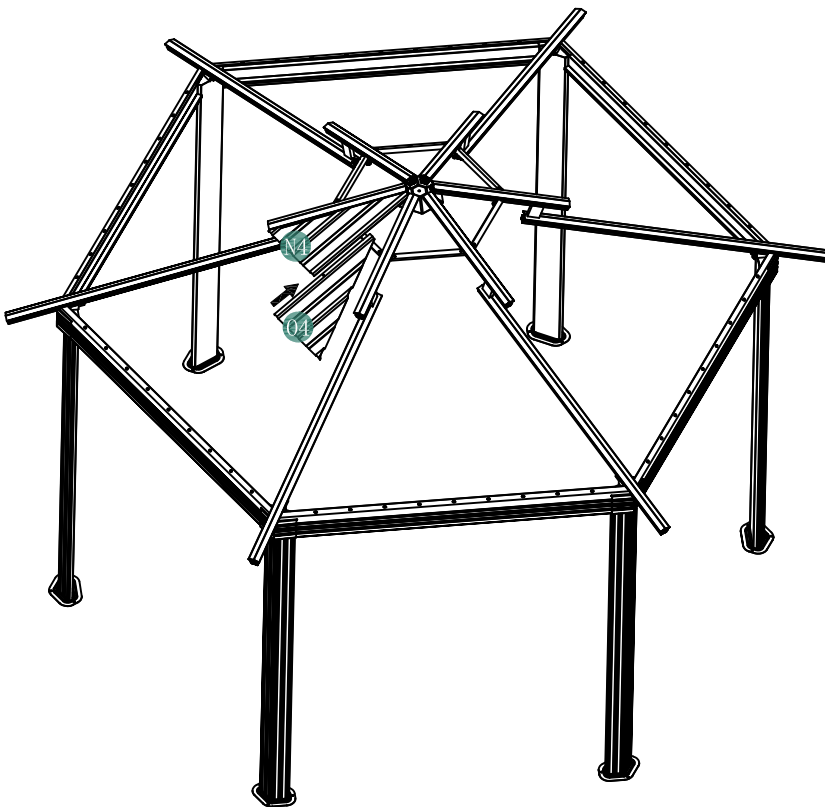

step9

Fix M2 with X to 6 roof Corner ,but do not screw too tight, then install the fix beams(G2) , finally tighten the (X)

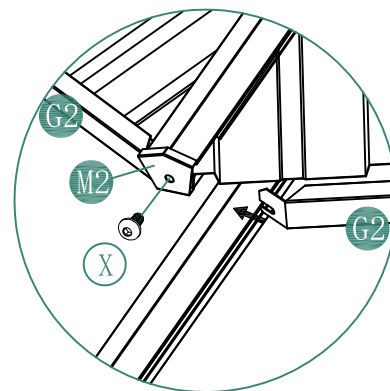
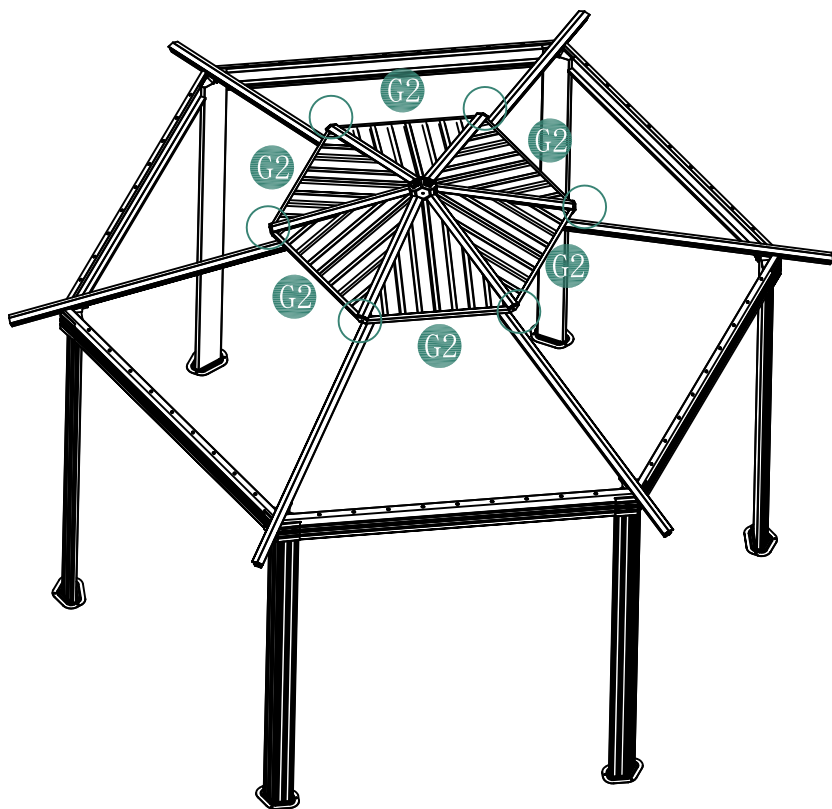

step10

Attach the 2 roof supports(K/K1) to connectors(M7)

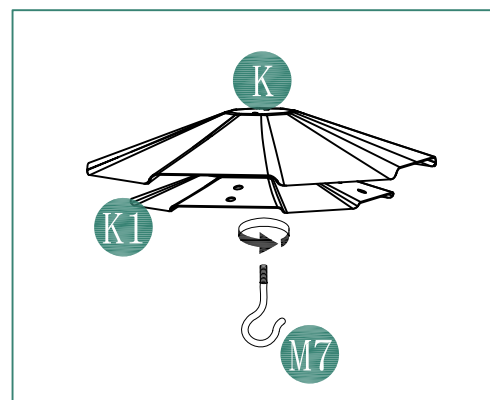
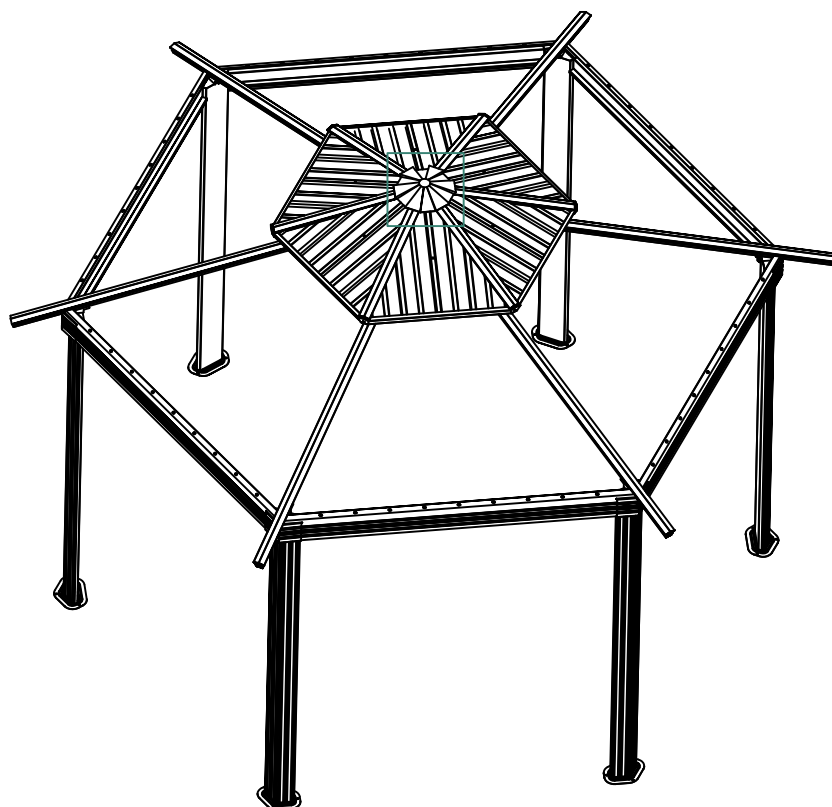

step11

Attach the 2 roof supports(H) to connectors(M3), fix by using Bolt (X)

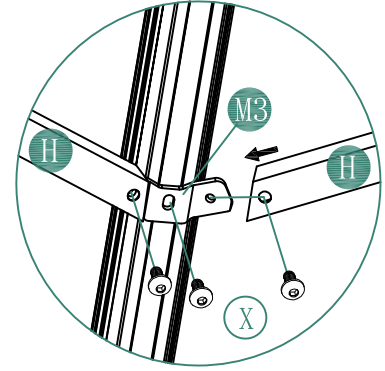
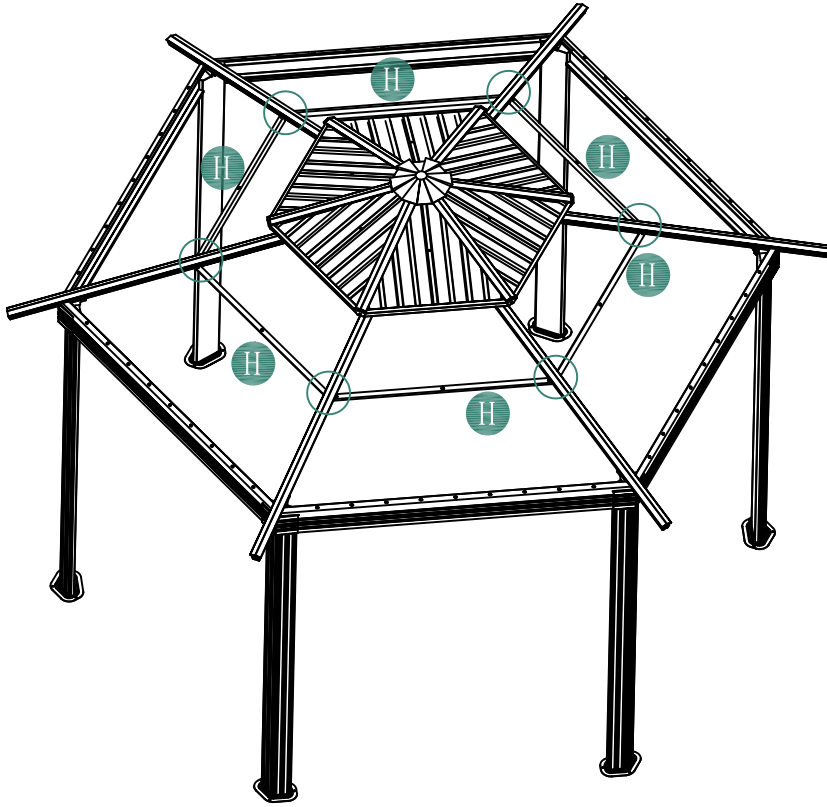

step12

Attach the clips(R1) and clips(R) as shown in the diagram

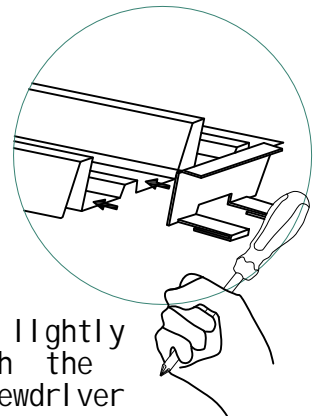
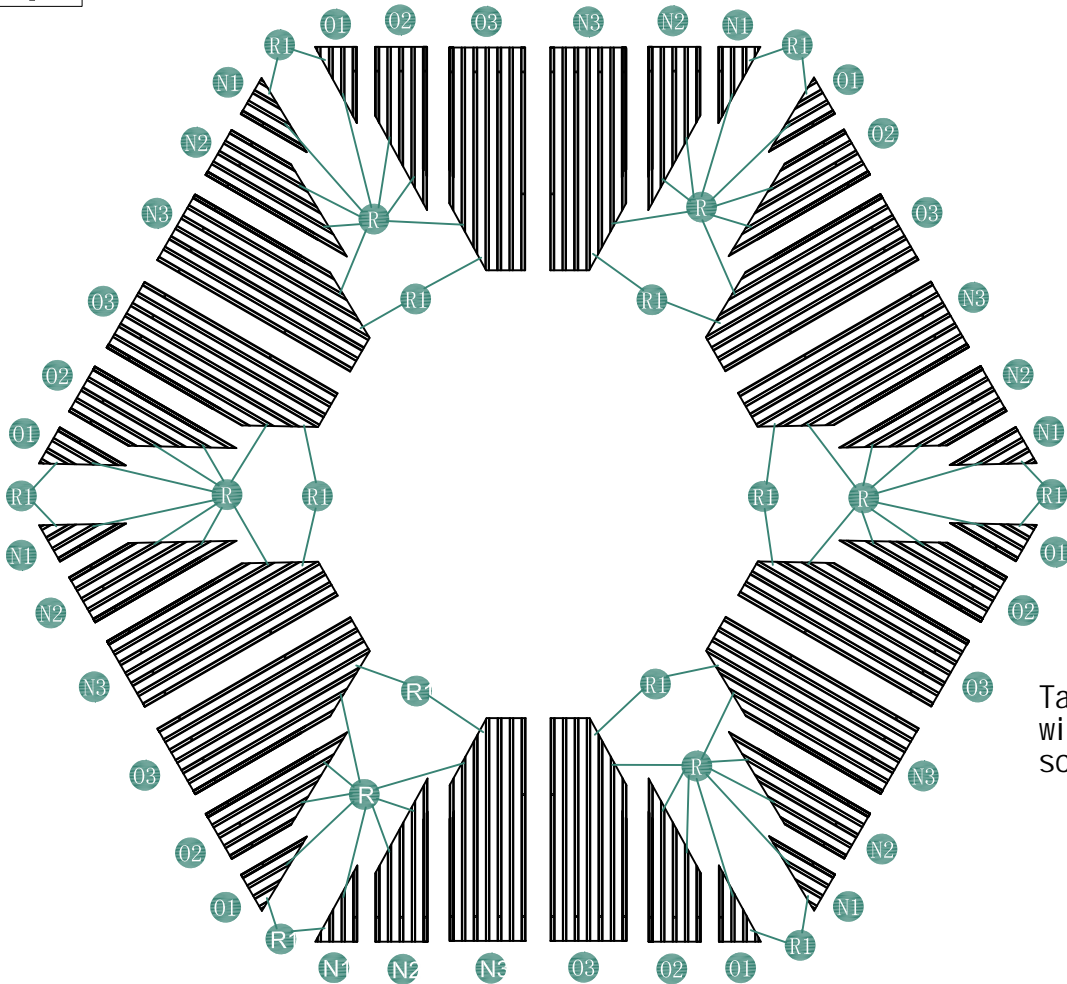

Tap lightly with the screwdriver

step13



step14 Install the Roof Plates (O1, O2, O3, N1, N2, N3) on the short Sides of the Gazebo. fix by using bolt (X5, X3)
Please note that when installing the screws (X3 and M5) again, you need to put on M5

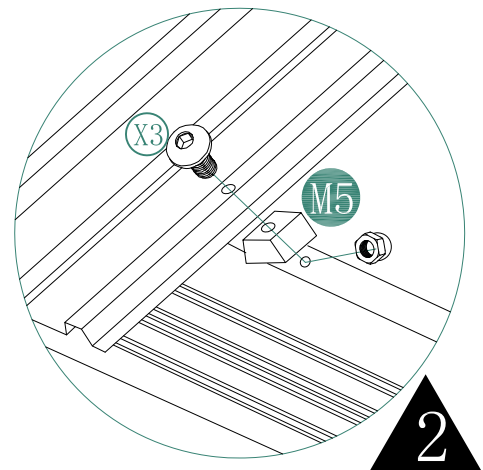
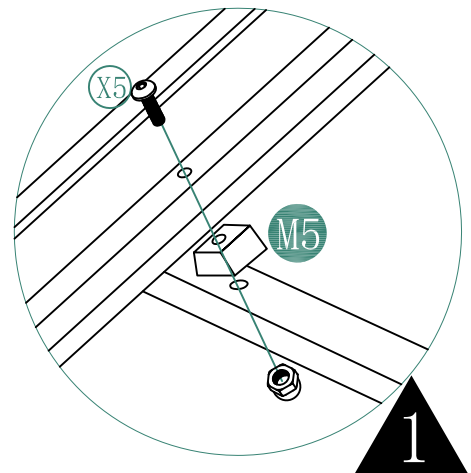
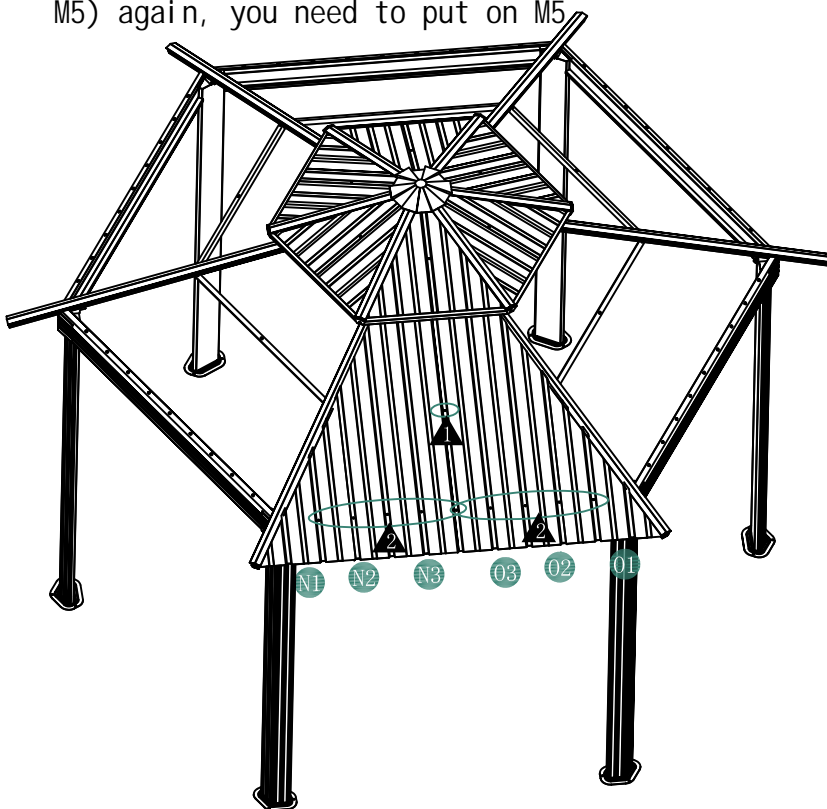

step15

Fix M2 with X to 6 roof Corner , but do not screw too tight, then install the fix beams(G1) , finally tighten the (X)

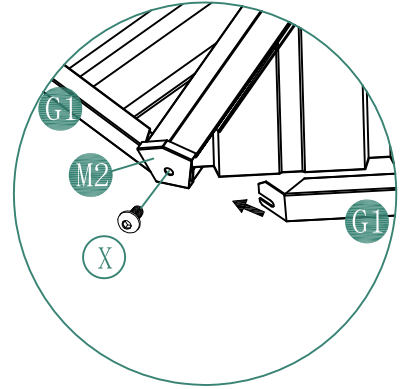
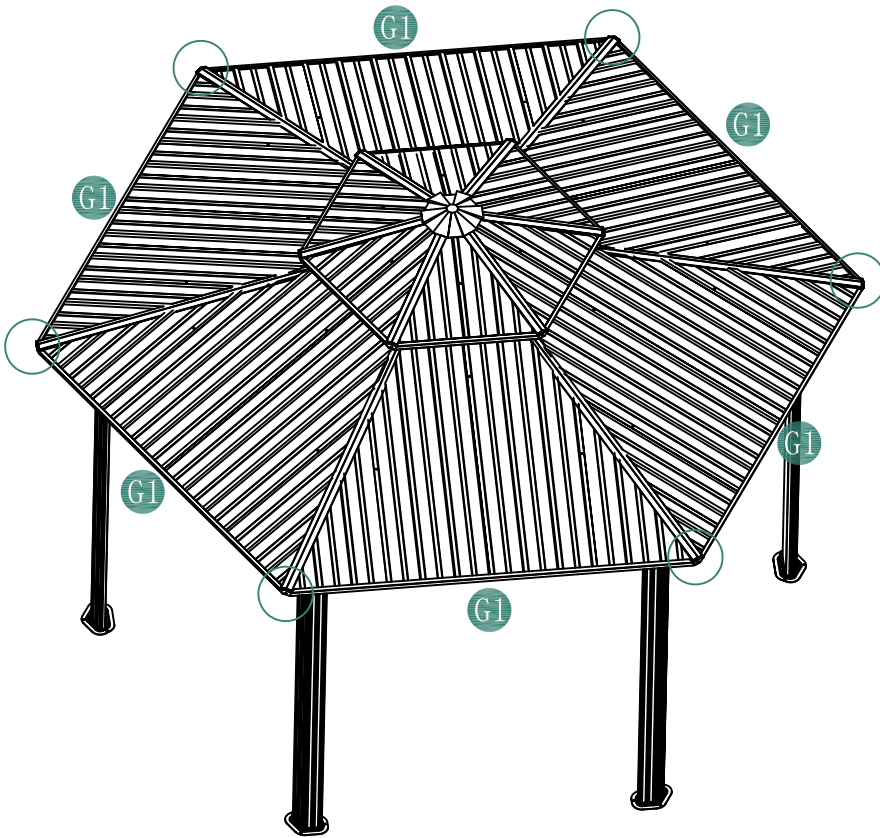

step16

Install the fix beams (G3)

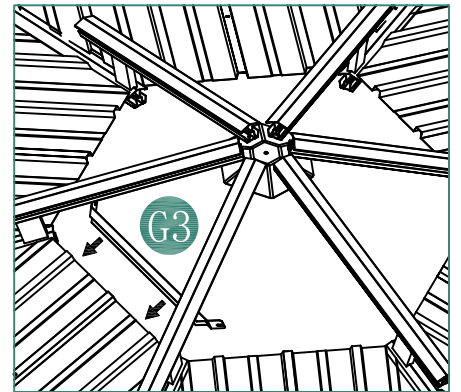

step17 Install the fix baffle (Z2)

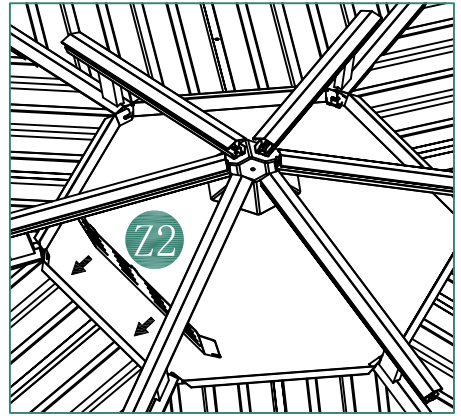
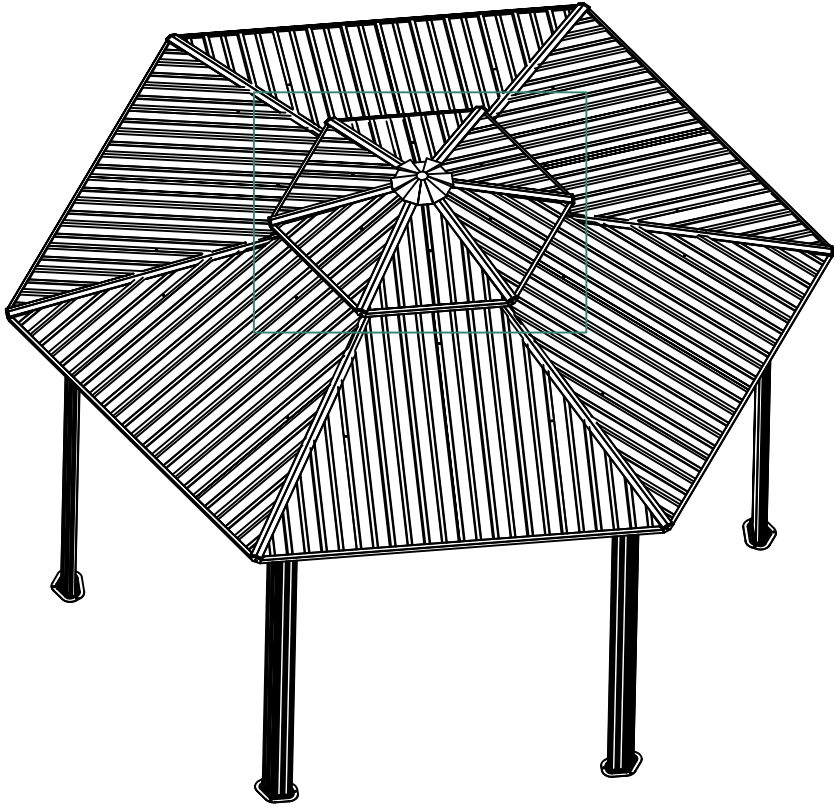

step18 Finally tighten the (X4)

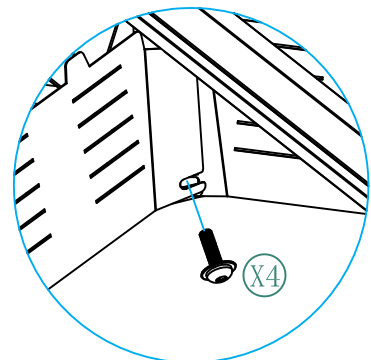
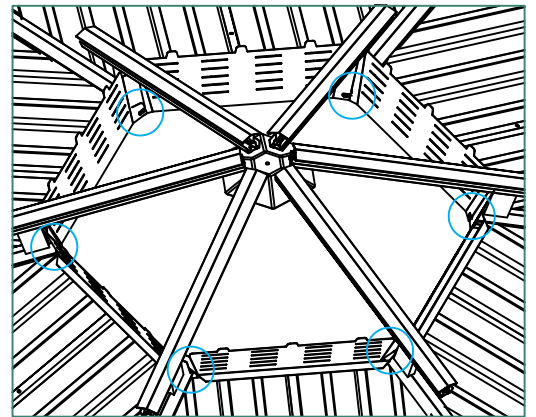

step19

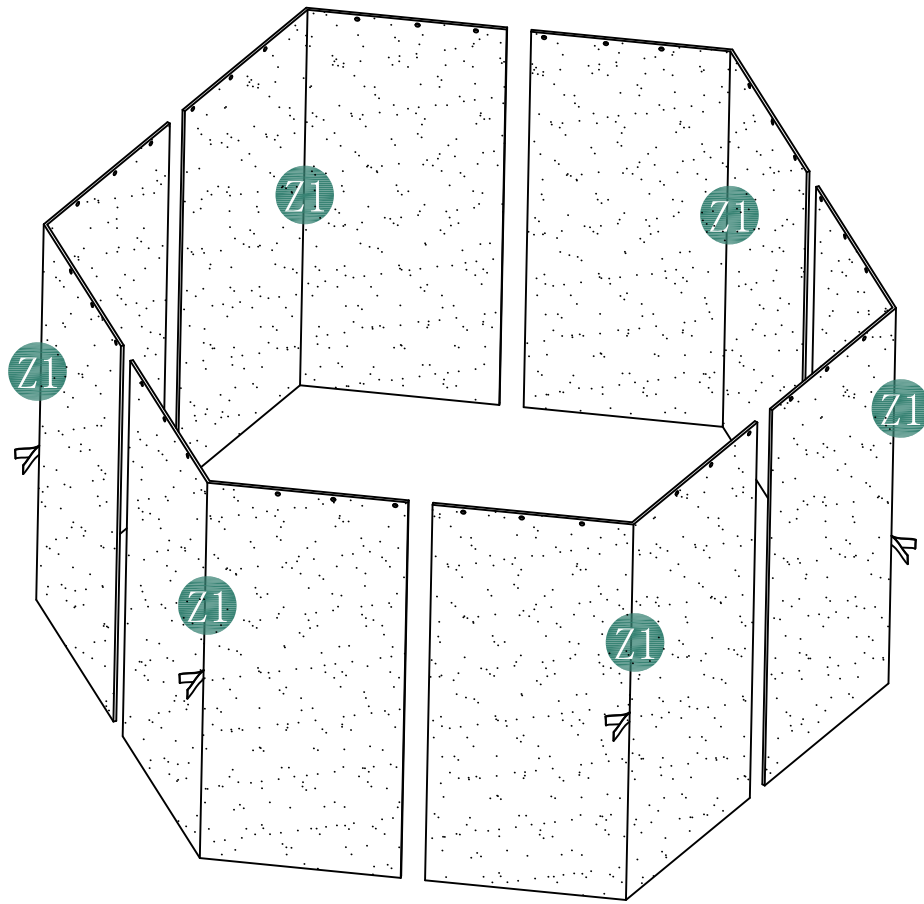

step20

Install the mosquito netting as shown in the diagram

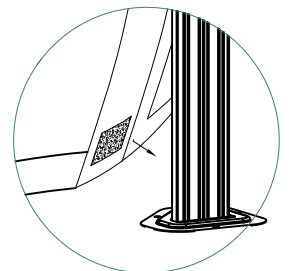
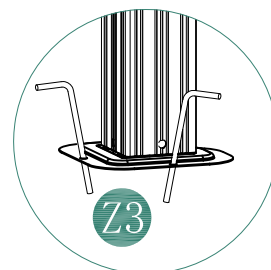
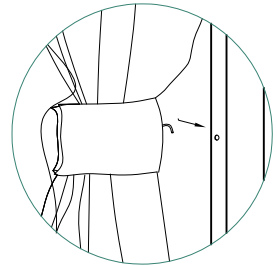
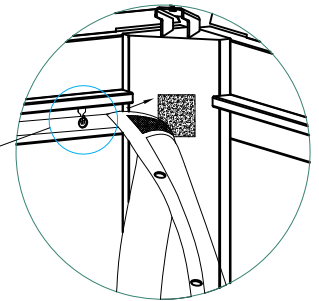
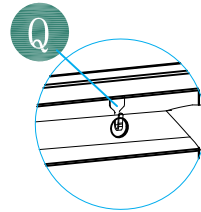
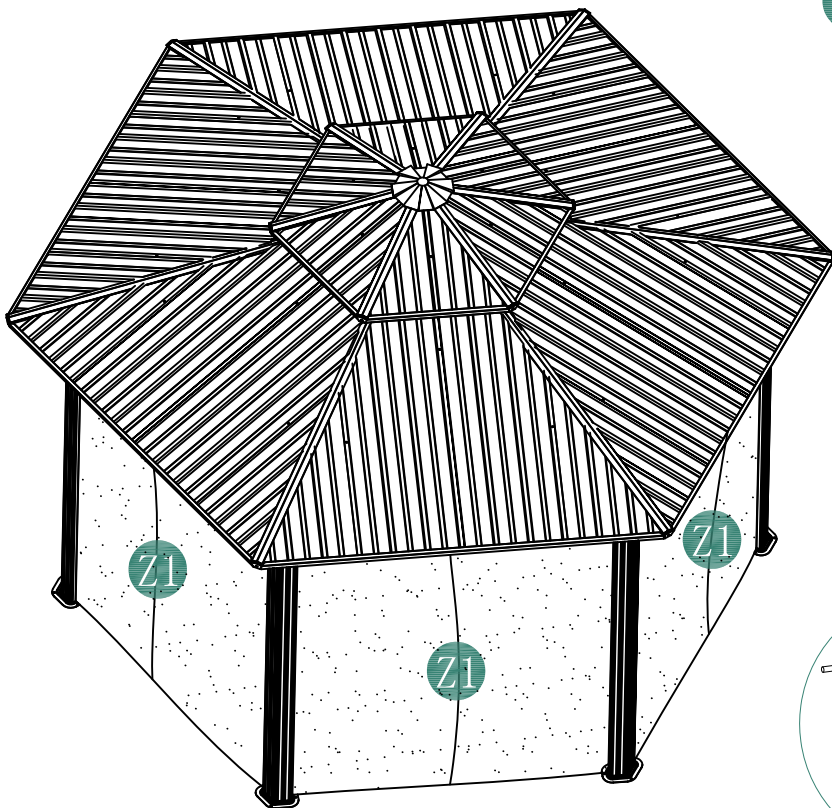



Call us First!
DO NOT RETURN TO STORE

For immediate help with assembly or product information

call our number:

888-328-5111

Or E-mail:

service@mondawe.com

Our staff is ready to provide assistance

M-F 9:00 AM to 5:00 PM EST