

HZDF-V1

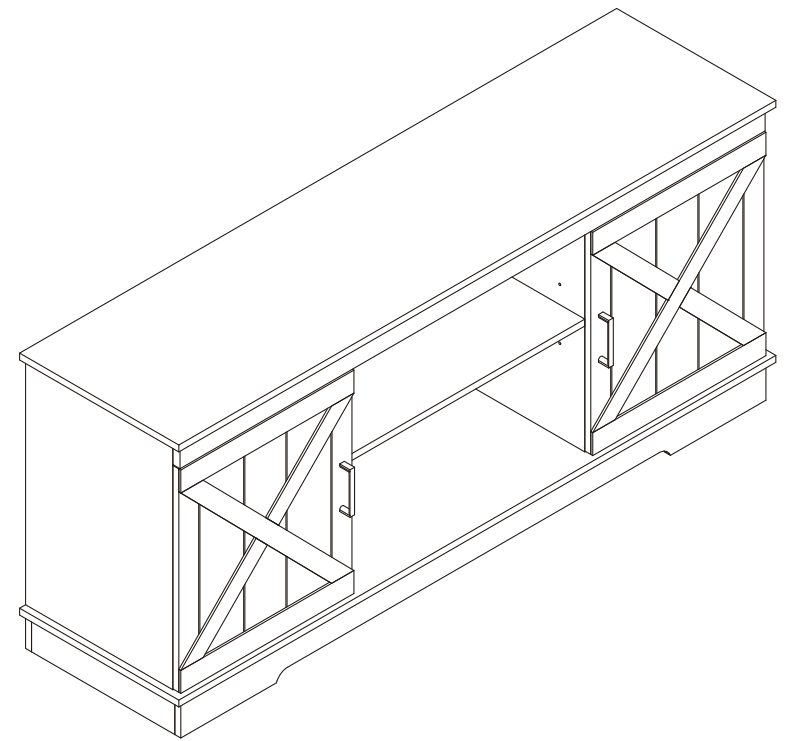









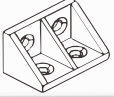



FTLFTS-0002  
FTLFTS-0006  
FTLFTS-6002  
FTLFTS-6045

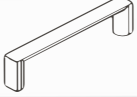









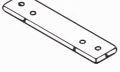

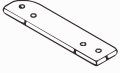
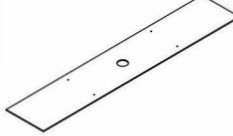
**IMPORTANT, RETAIN FOR FUTURE REFERENCE: READ CAREFULLY**

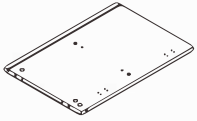
**Notice:**

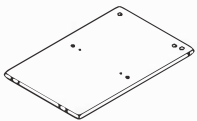

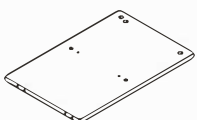
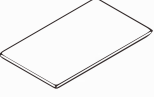
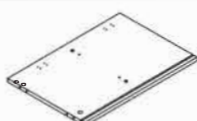
1. Follow the installation instructions. Please confirm all accessories are preset before installation.
2. Do not fully tighten the screws during initial assembly. Fully tighten screws only once all pieces which are correctly assembled.
3. If you encounter any problems during installation, refer to two solutions: Follow the installation video tutorial on the Amazon product page or contact our customer service.

Item no.	Reference Image	Qty.	Item no.	Reference Image	Qty.
(A)		×36 +2	(G)		×6
(B)		×36 +2	(H)		×8
(C)	 ∅8×30	×24 +2	(I)	 M4×22	×4
(D)	 M7×48	×8	(J)		×2
(E)	 M3.5×14	×48 +2	(K)		×4
(F)		×8	(L)		×4
(M)		X10	(-)		-
			(N)		X10

Item no.	Reference Image	Qty.	Item no.	Reference Image	Qty.
(1)		×1	(8)		×2
(2)		×1	(9)		×2
(3)		×2	(10)		×2
(4)		×1	(11)		×1
(5)		×1	(12)		×1
(6)		×1	(13)		×1
(7)		×1	(14)		×1
			(1)		×2

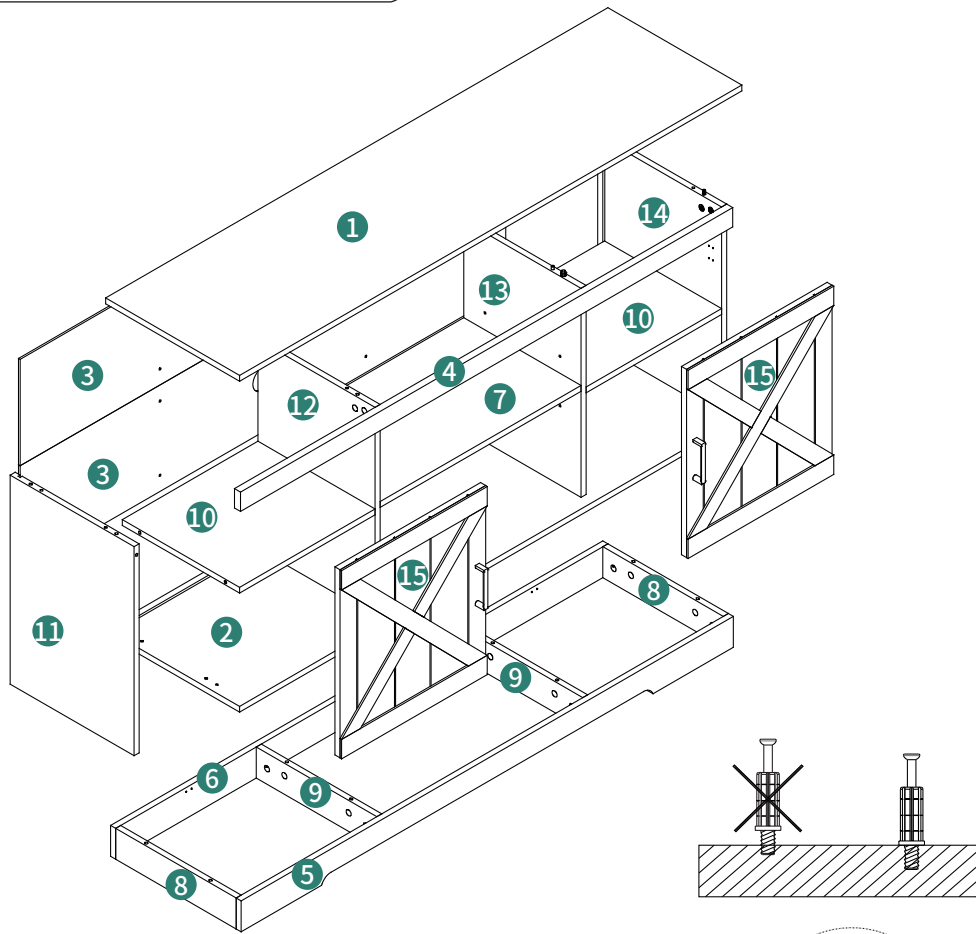
# Explosion Diagram

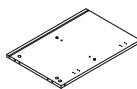
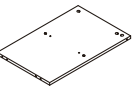
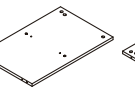
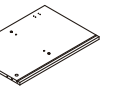

- 1**
-  ⑪ 1PCS
  -  ⑫ 1PCS
  -  ⑬ 1PCS
  -  ⑭ 1PCS
  -  ① 8PCS

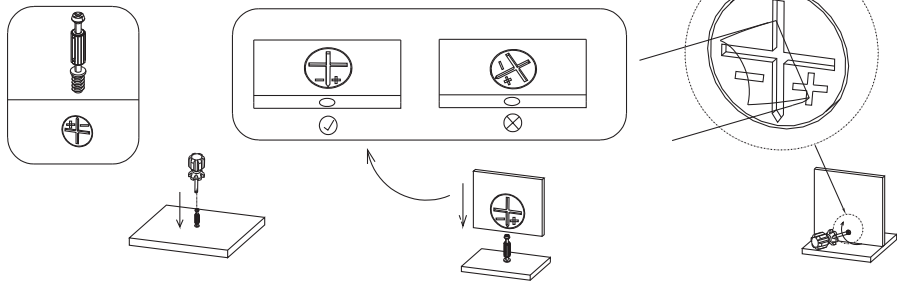

3

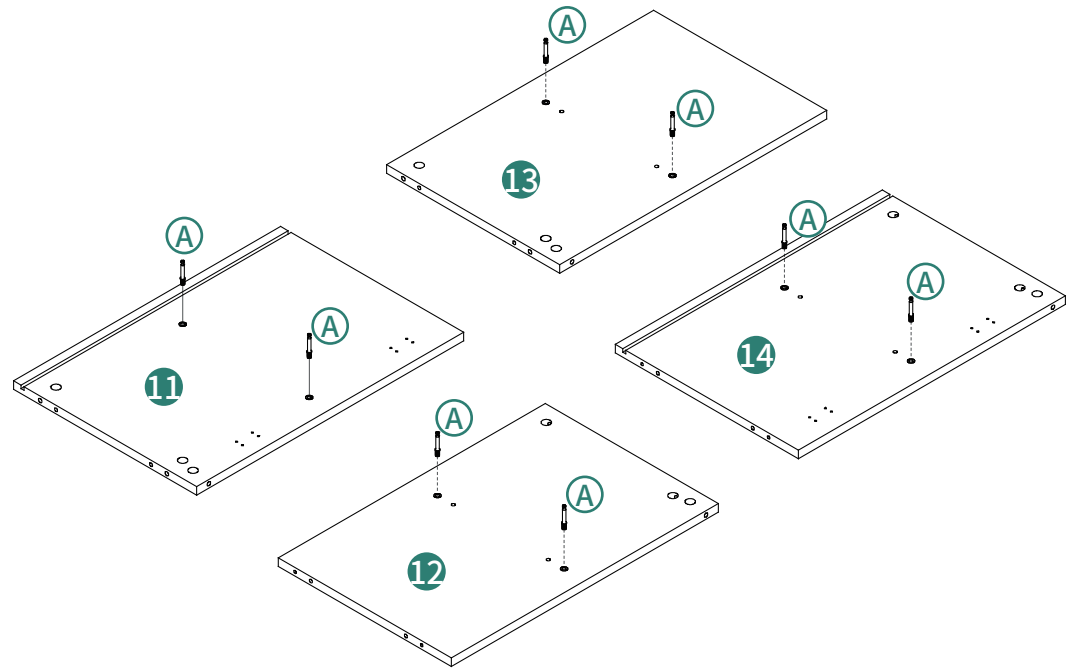

4

2

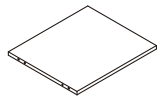

⑩ 2PCS



Ⓑ 8PCS



Ⓒ 8PCS

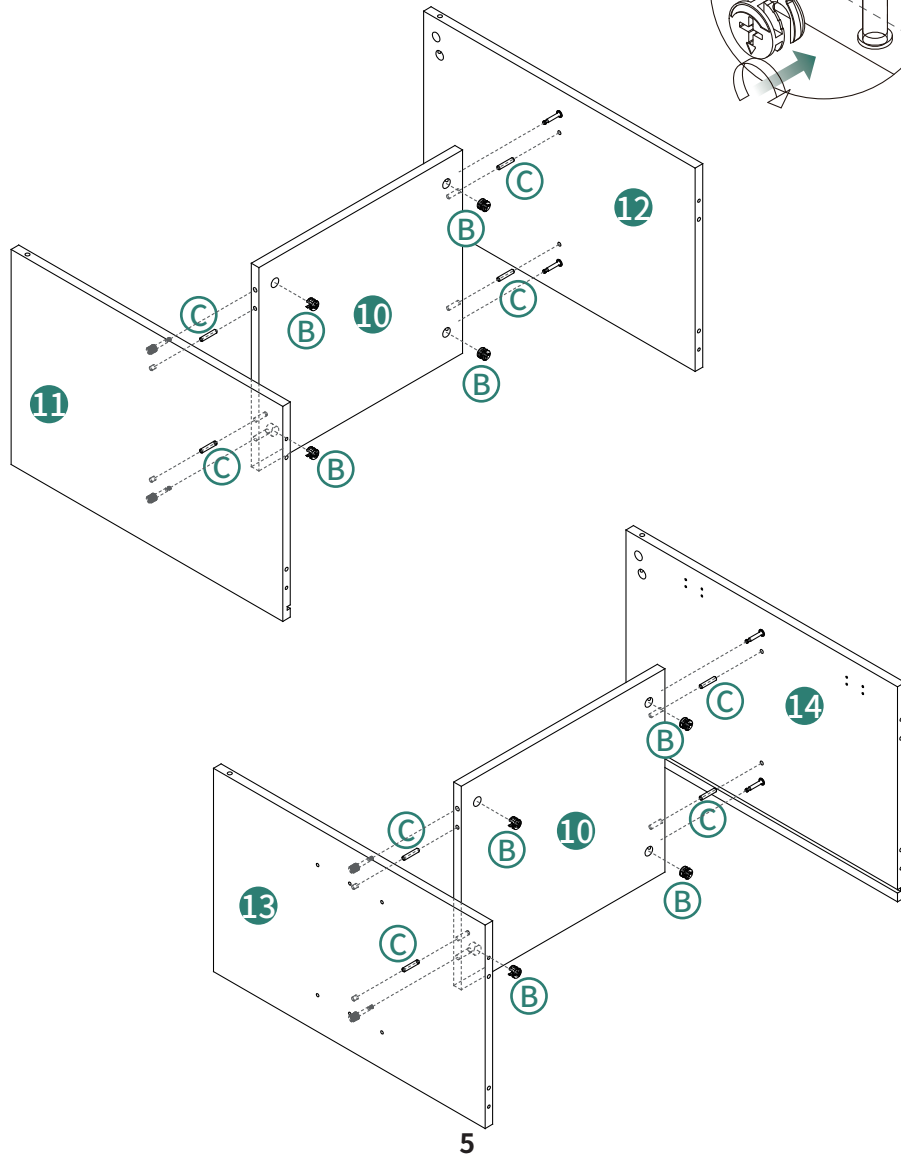
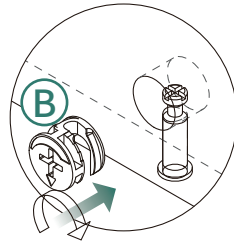

5

3

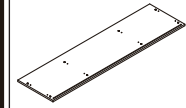

① 1PCS



Ⓐ 8PCS

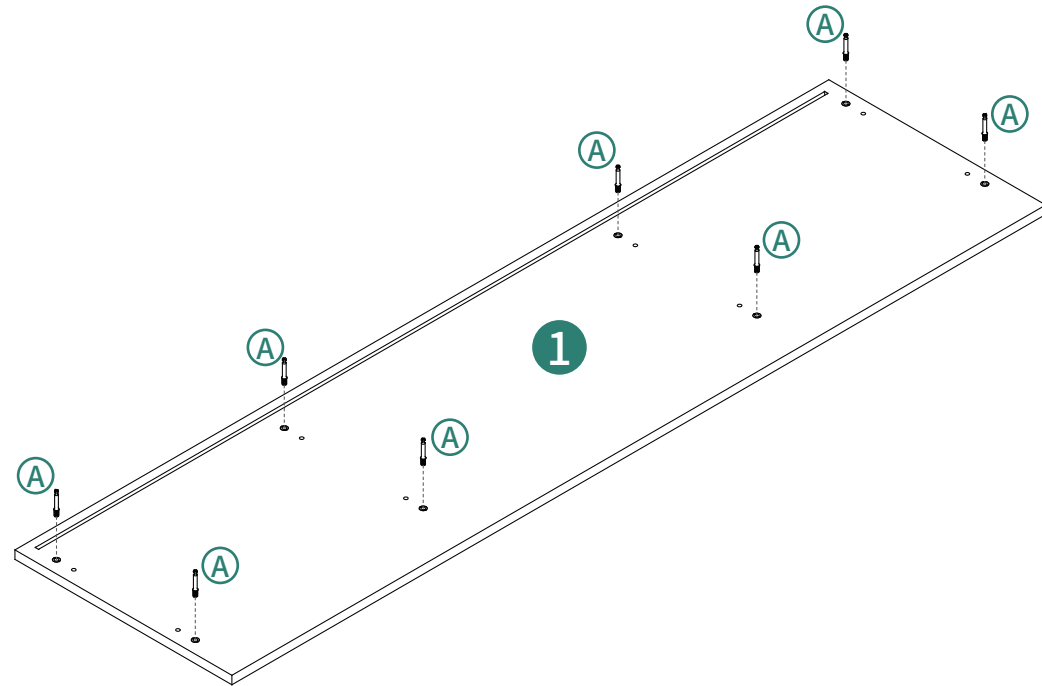

6

4

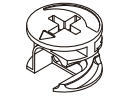

Ⓑ 8PCS



Ⓒ 8PCS

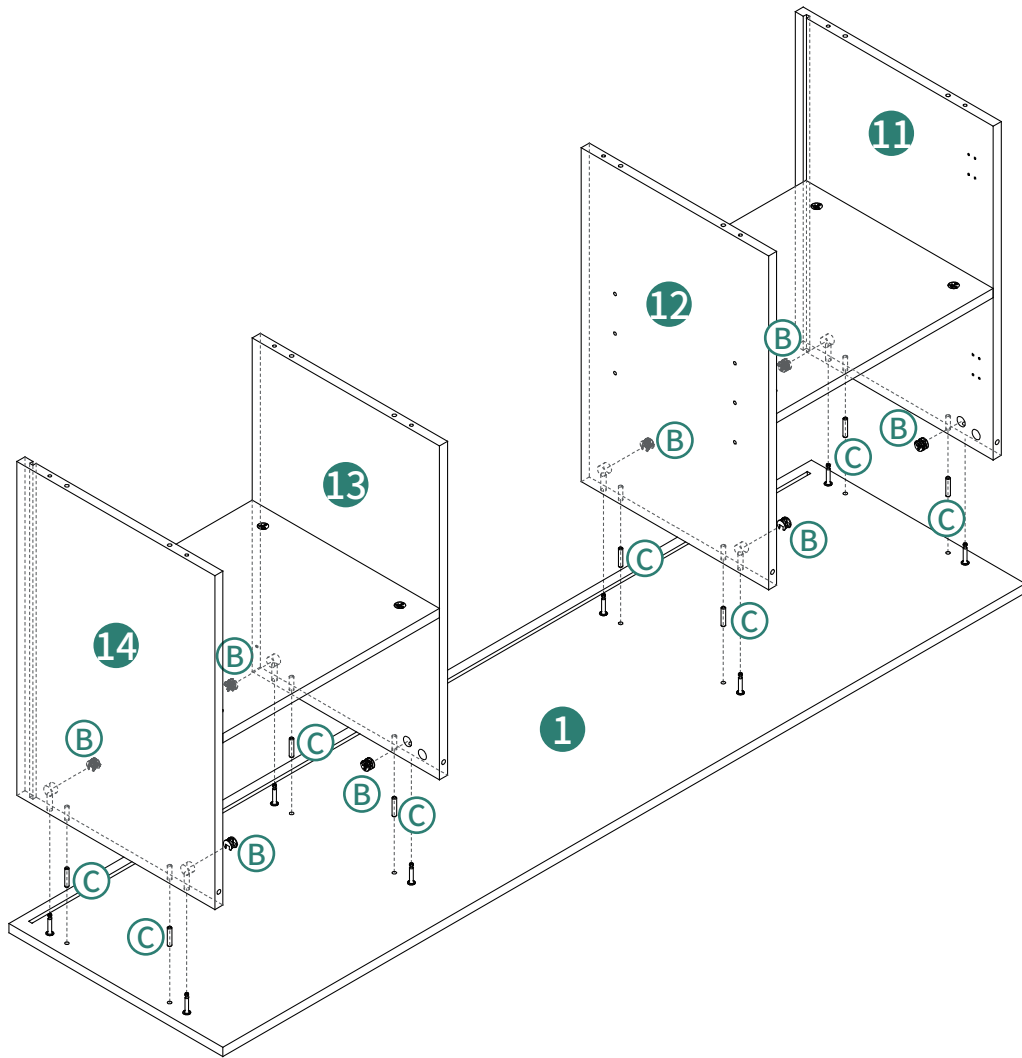

7

5

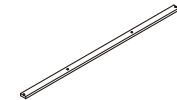

Ⓓ 1PCS



Ⓐ 4PCS



Ⓑ 4PCS

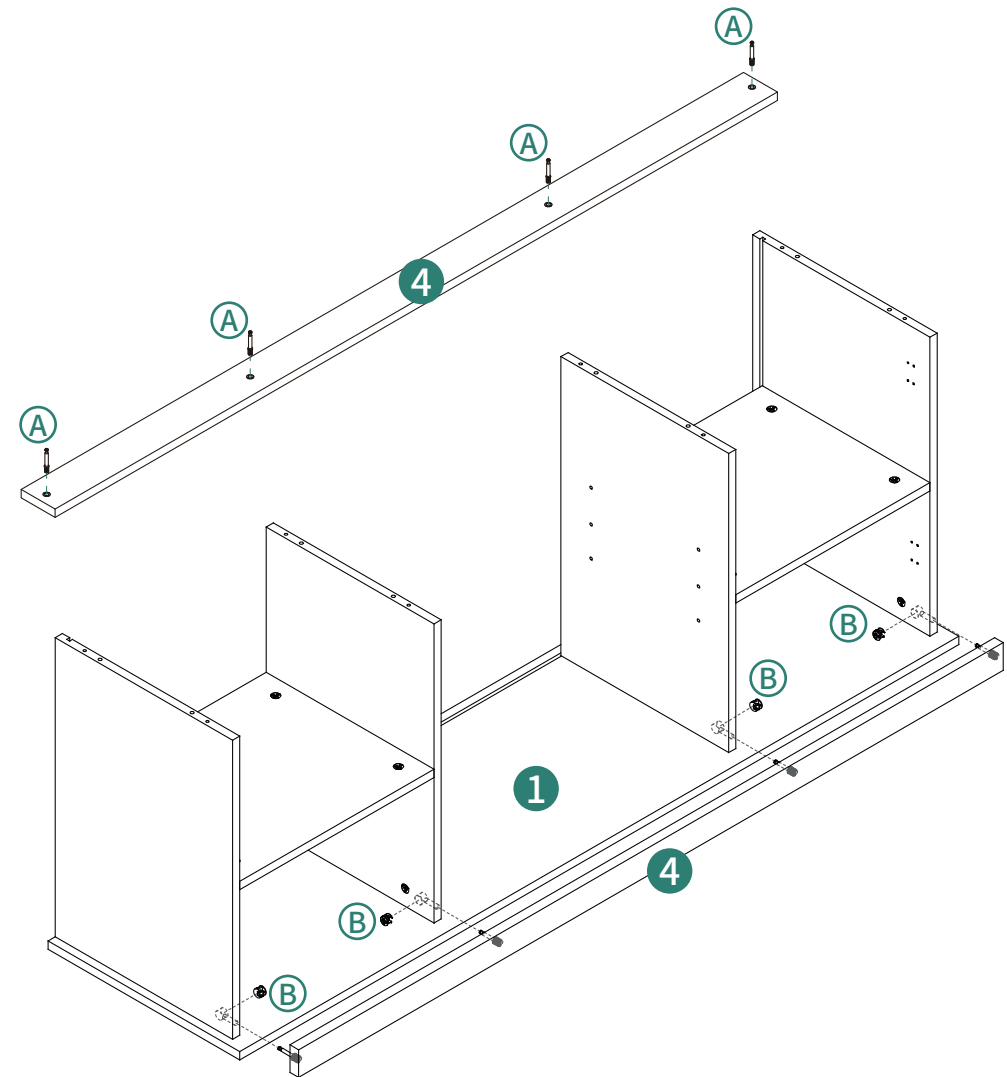

8

6

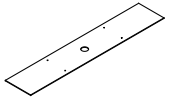

③ 2PCS

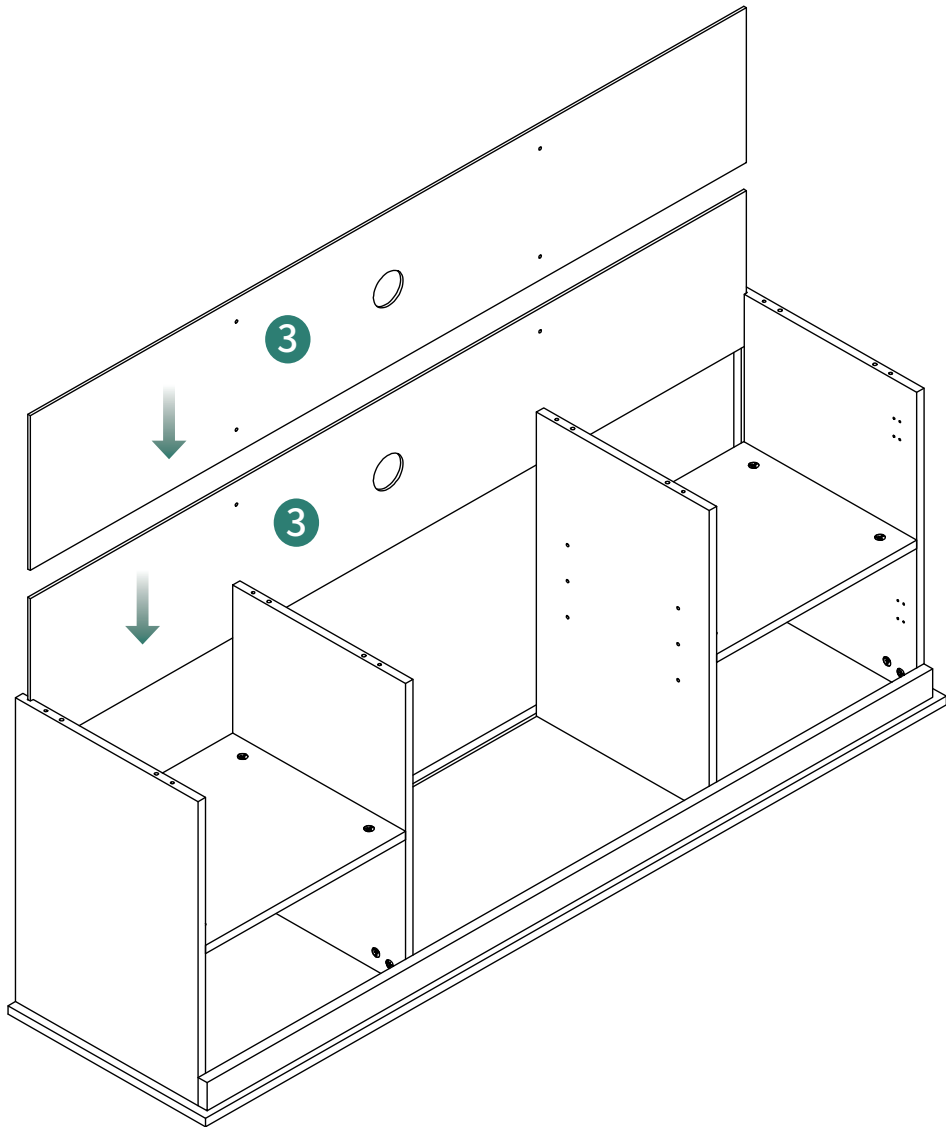

9

7

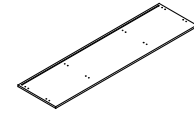

② 1PCS

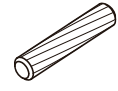

④ 8PCS



⑤ 8PCS

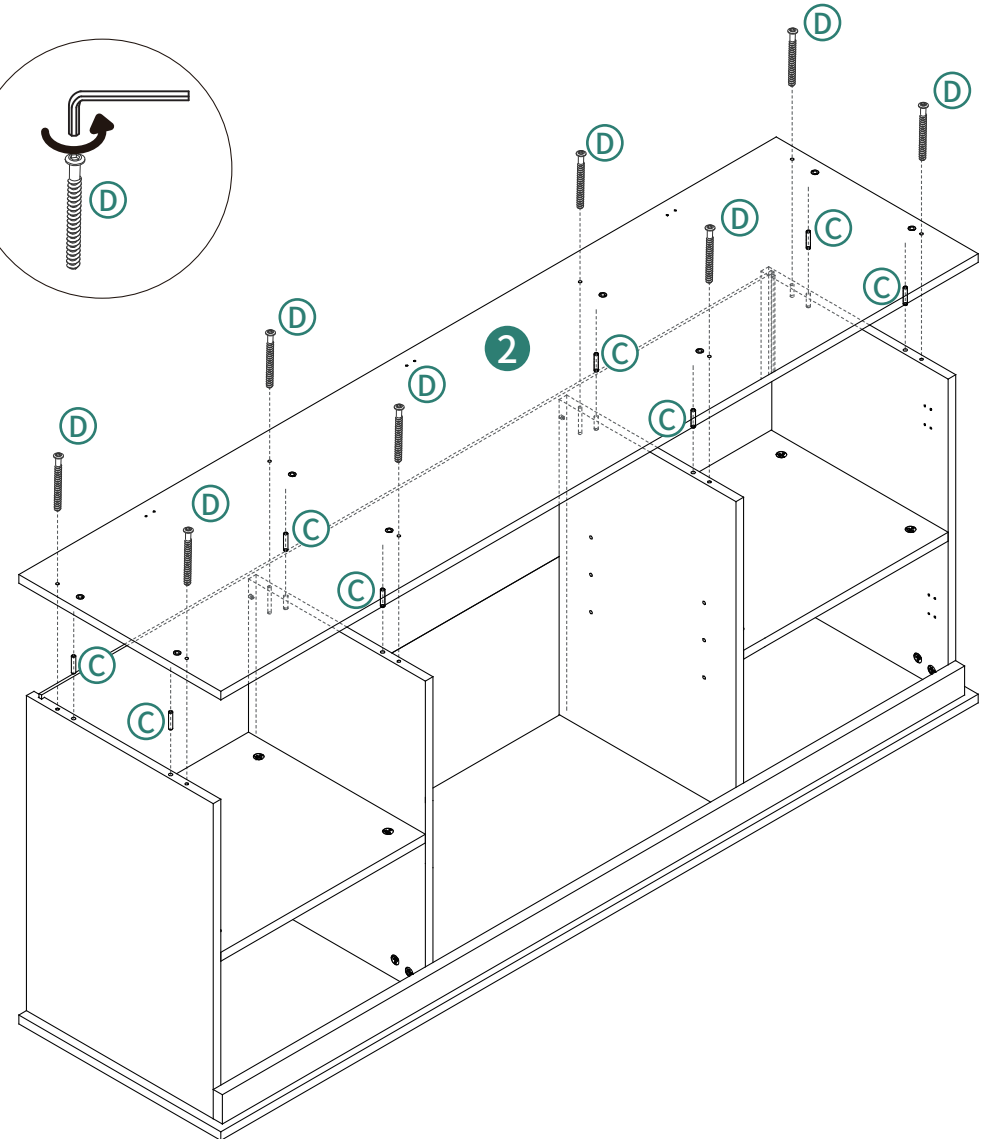
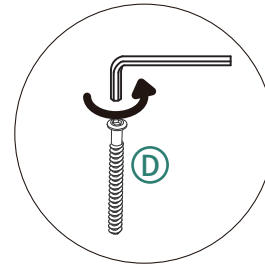

10

8

- ⑤ 1PCS
- ⑥ 1PCS
- Ⓐ 16PCS

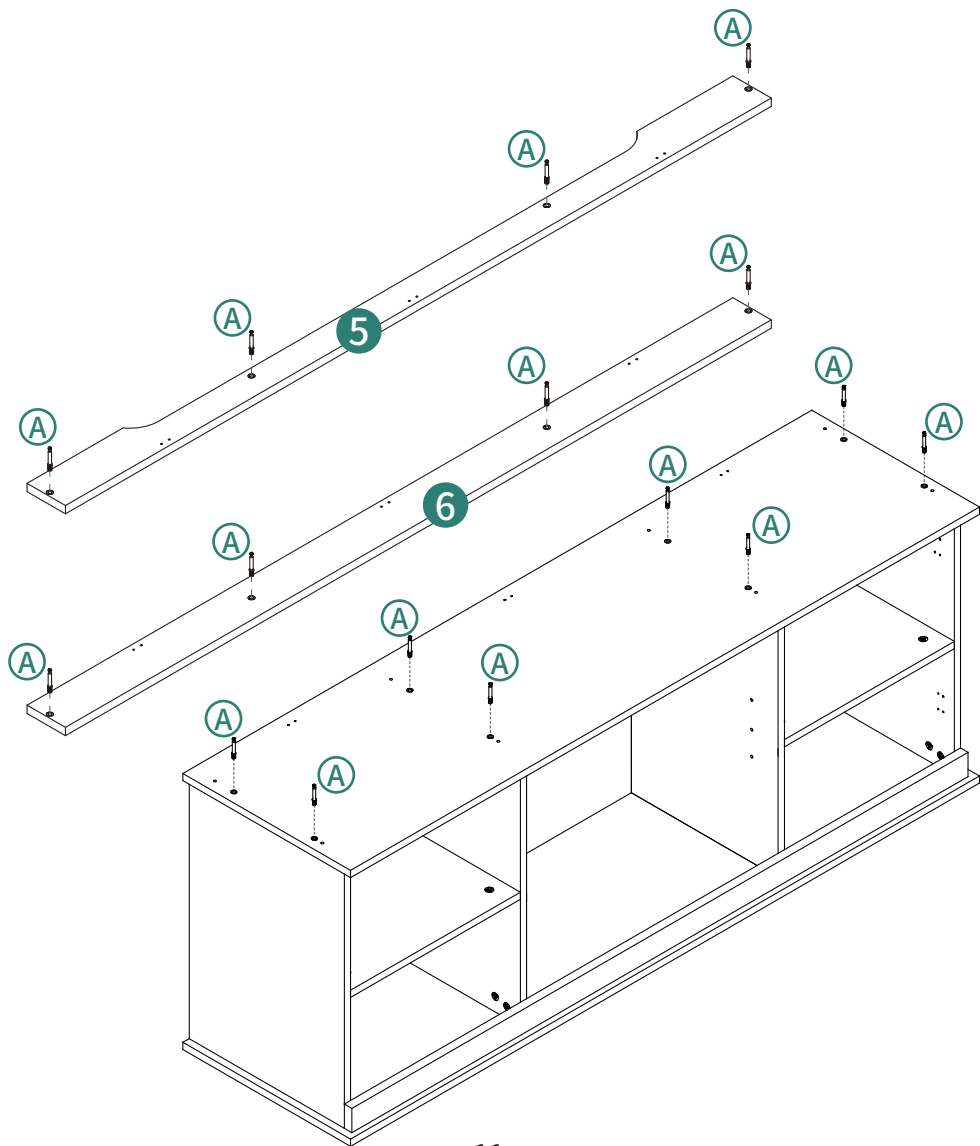

11

9

- Ⓑ 8PCS
- ⑧ 2PCS
- ⑨ 2PCS

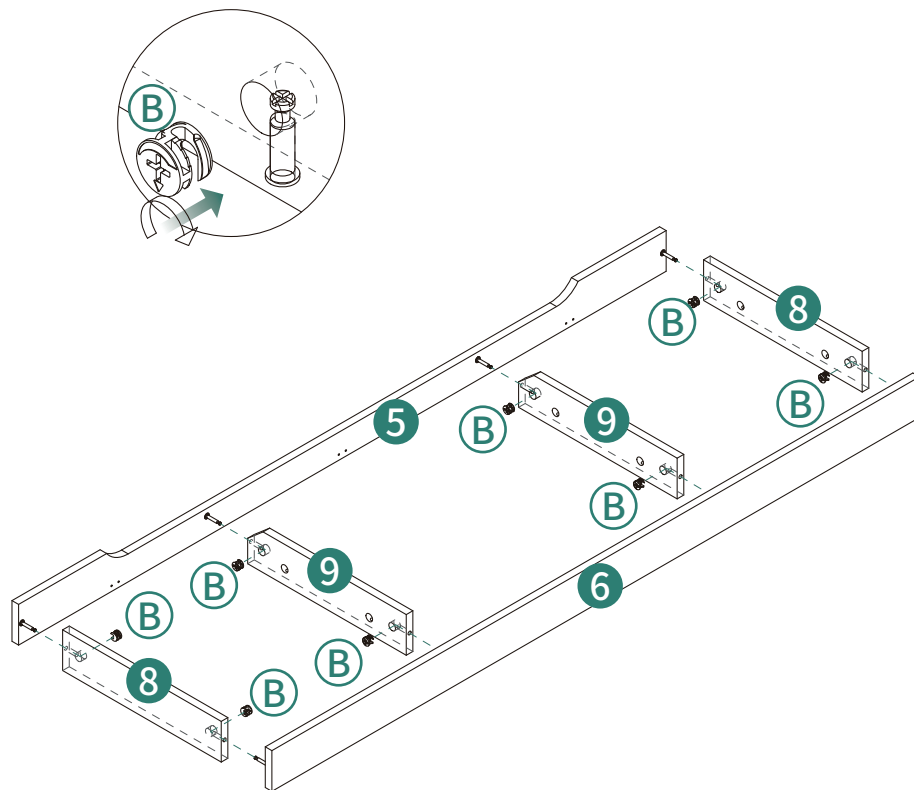

12

10



Ⓑ 8PCS

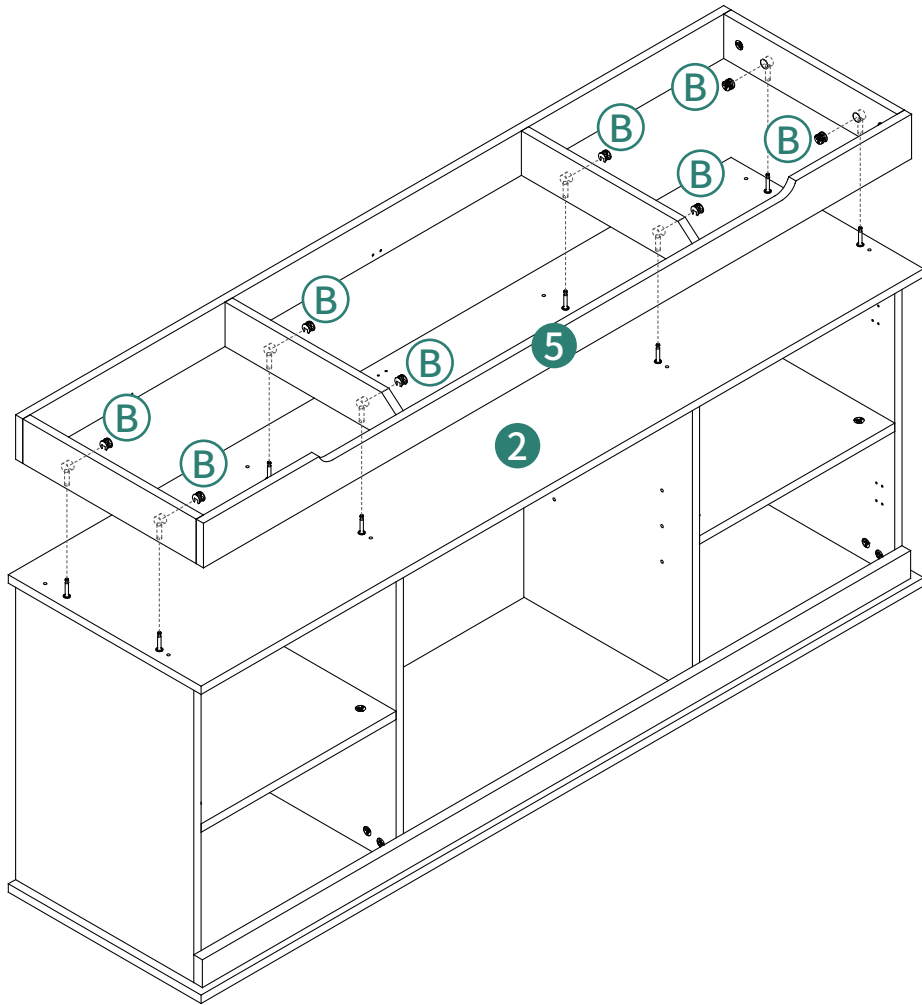

11



Ⓔ 24PCS

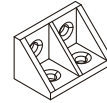

Ⓖ 6PCS



Ⓕ 8PCS

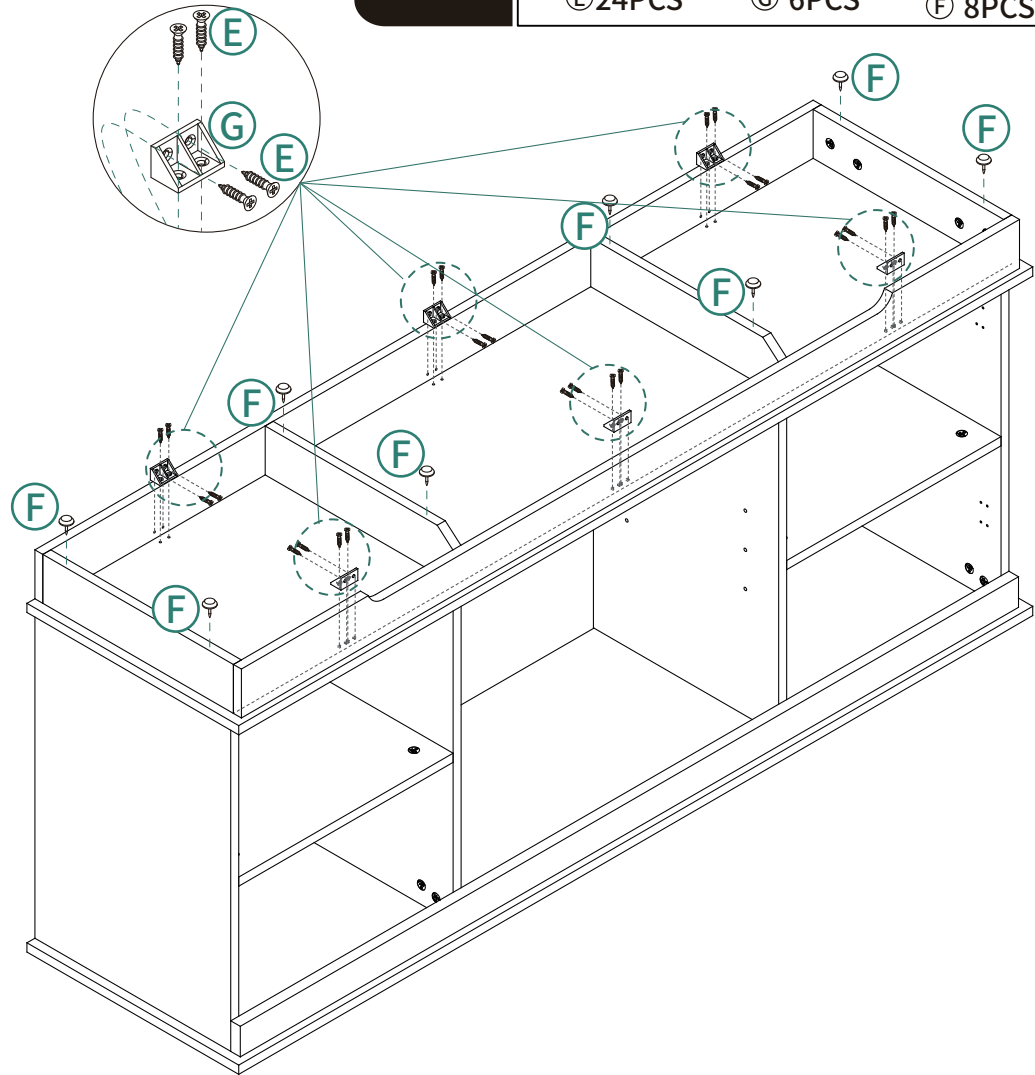

12



L 4PCS

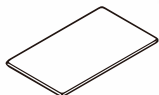

7 1PCS

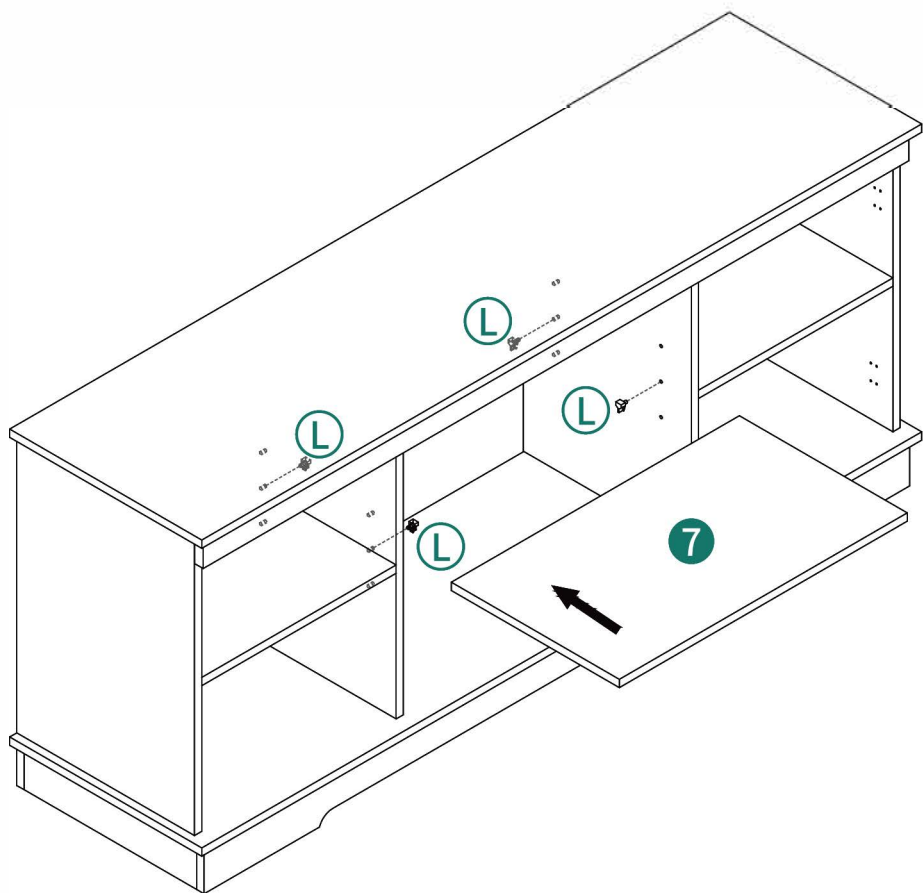

15

13



H 8PCS



M 10PCS

M3x16



N 10PCS

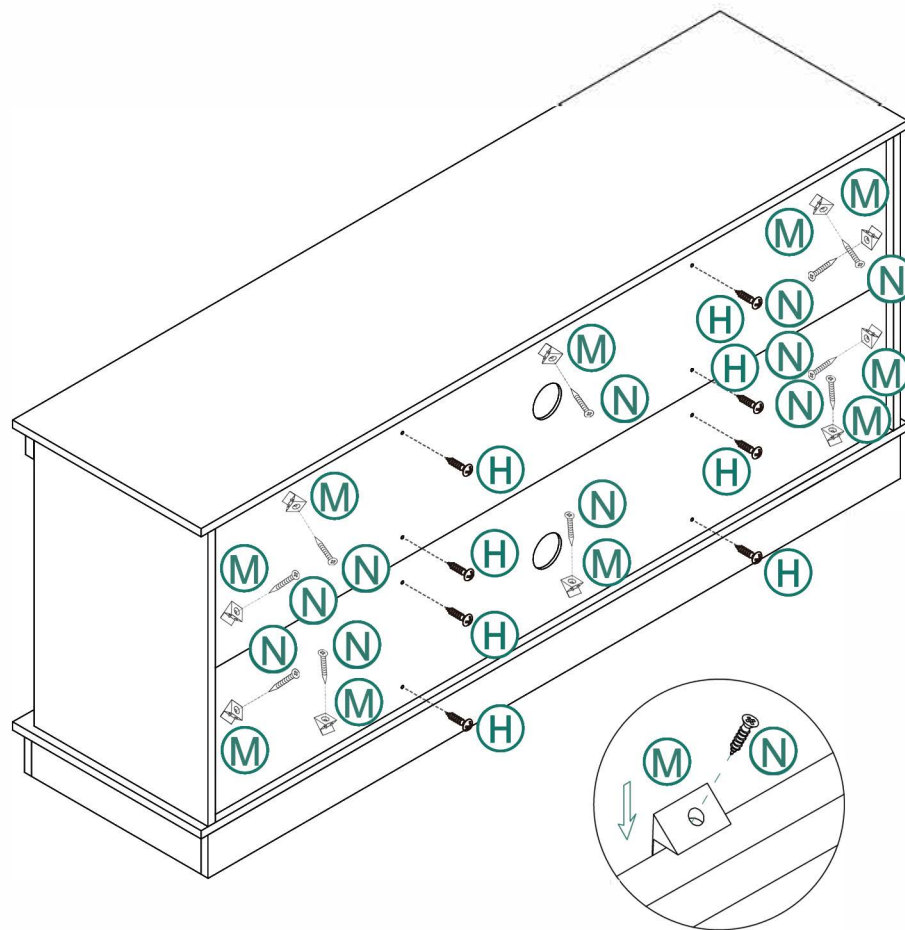

16

# 14

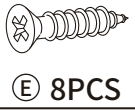

E 8PCS

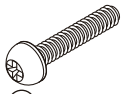

I 4PCS

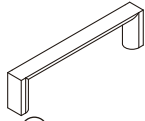

J 2PCS

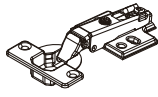

K 4PCS

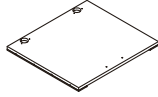

15 2PCS

## Sets X 2

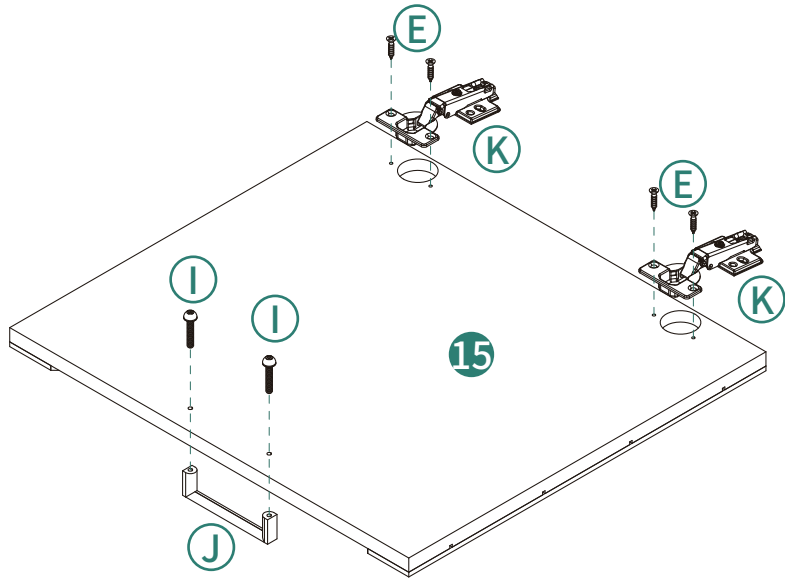

# 15

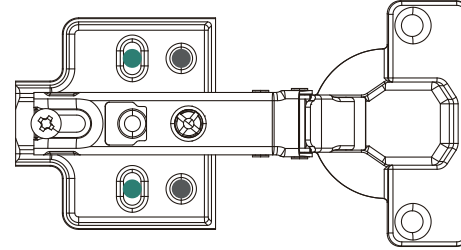

Up / Down

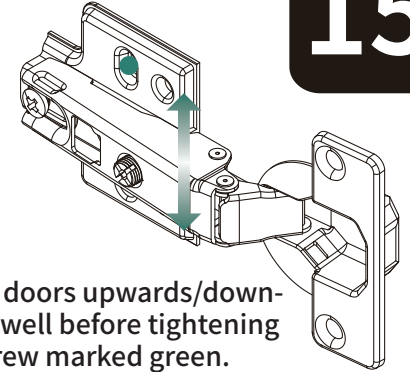

Adjust doors upwards/downwards well before tightening the screw marked green.

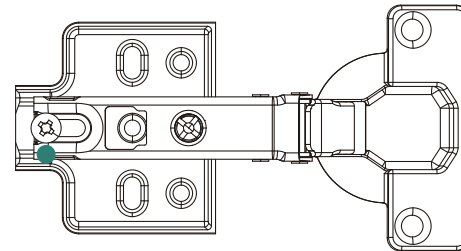

Before / After

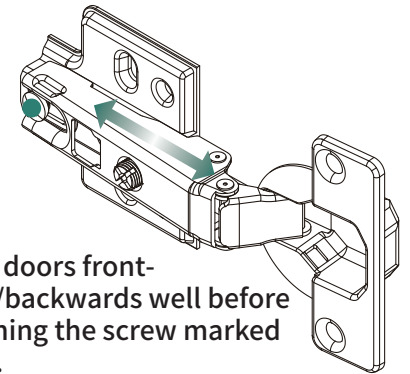

Adjust doors frontwards/backwards well before tightening the screw marked green.

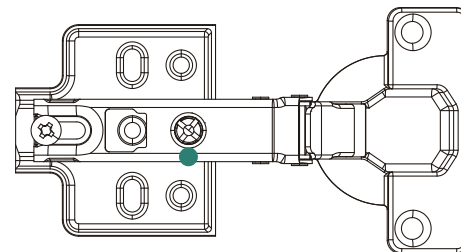

Left / Right

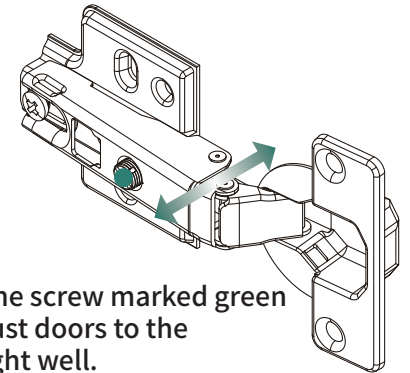

Turn the screw marked green to adjust doors to the left/right well.

16



ⓔ16PCS

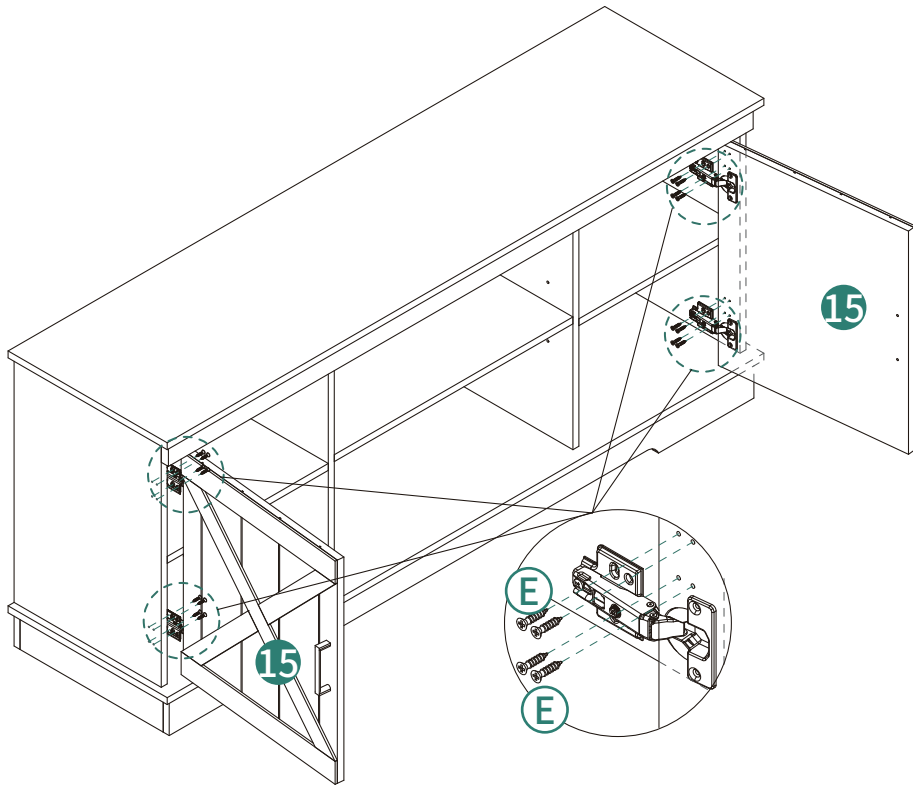

17

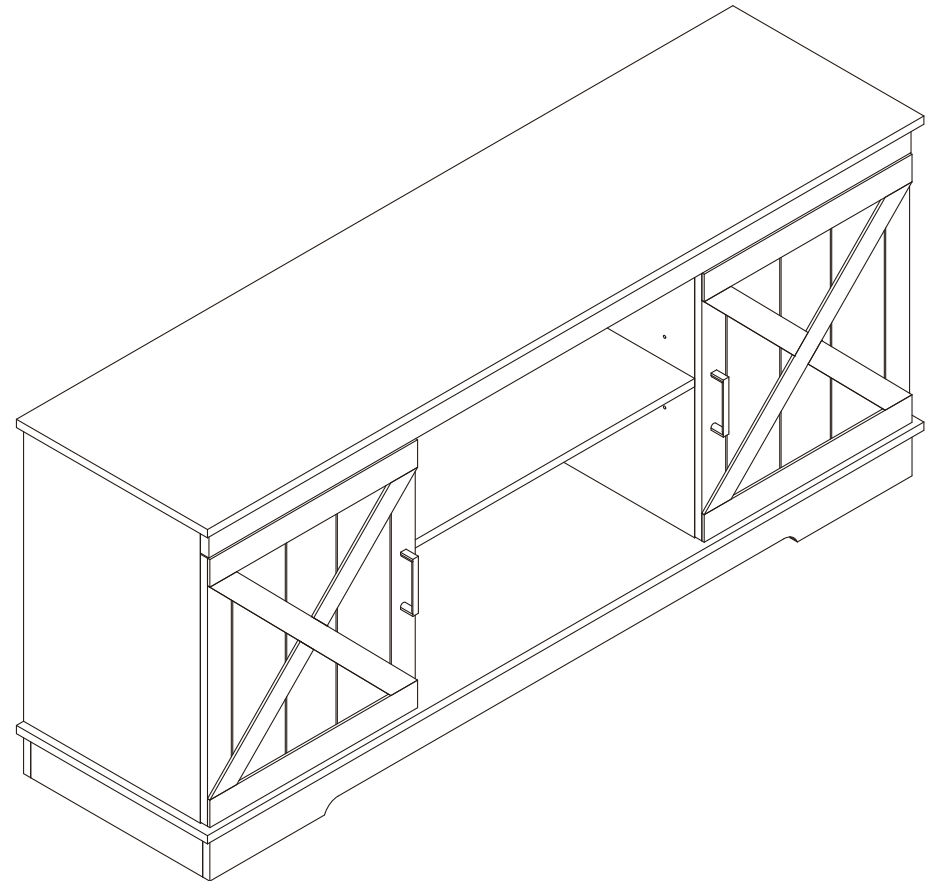

Installation Completed