 satin finish

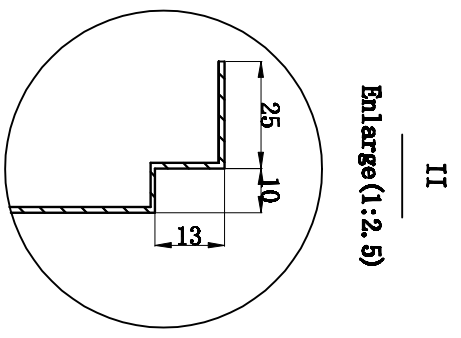
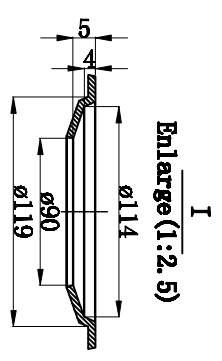
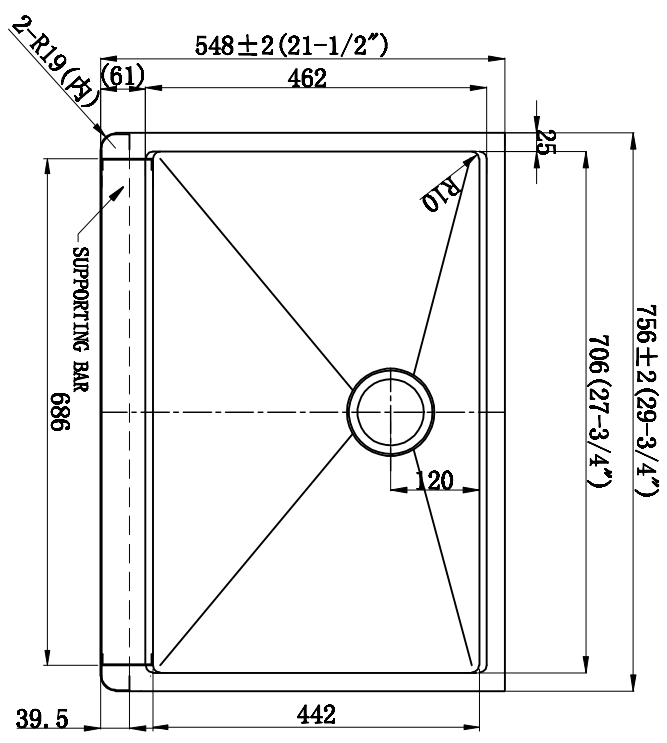
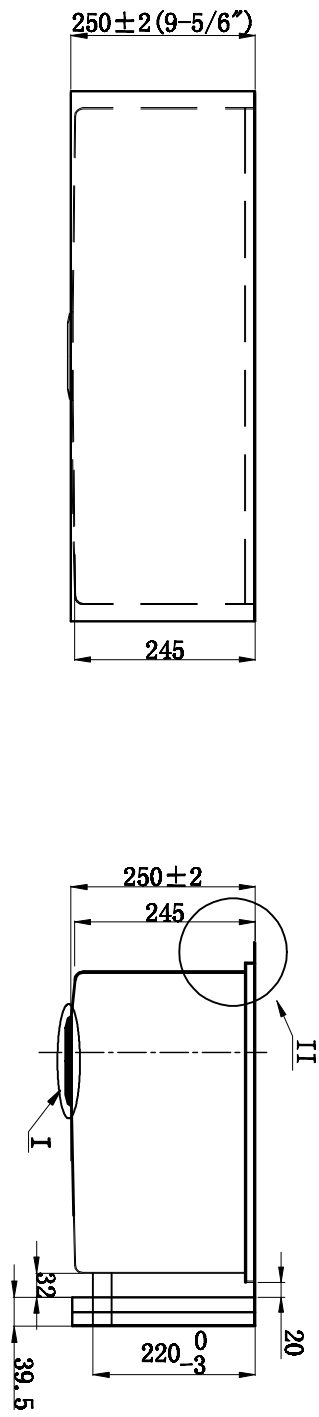

A30S
material&thickness SUS304 16GA
EMPIRE INDUSTRIES, INC.