



ASSEMBLY INSTRUCTION

ITEM NO.: 194S8230BLK/BRW/FBR-1

GLIDER RECLINING CHAIR

NOTE: Do not use power tools for assembly. Power tools increase the risk of over tightening which lead to splitting or cracking the wood.

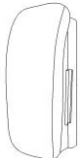
COMPONENT LIST

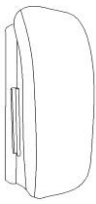
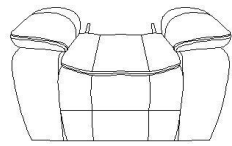
NO.	DRAWING	QTY	DESCRIPTION
A		1	LSF EAR
B		1	BACK REST
C		1	RSF EAR
D		1	SEAT

Please follow the drawings below to assemble the item.

Step 1. Align the female brackets at the back rest onto the male brackets at the seat, insert and push to the end, make sure the brackets are secured in position.

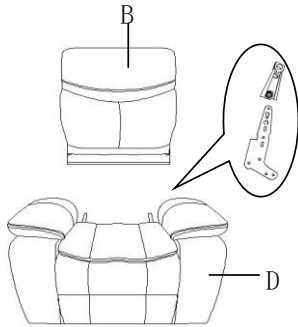

Step 2. Insert the LSF ear and RSF ear to the back rest and make sure it is secured in position.

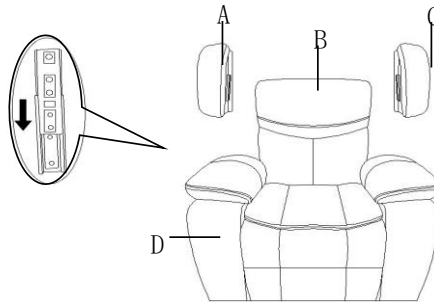

Step 3. Completed

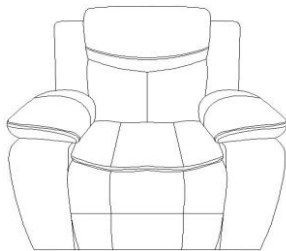

CARE INSTRUCTION FOR LEATHER GEL MATCH FURNITURE

- **Avoid exposing furniture directly to sunlight or heating and air conditioning outlets. Exposure to sunlight or heating and air conditioning outlets will fade/damage leather gel match.**
- **Wipe gently with a damp soft cloth to remove dust, dirt and any grime buildup.**
- **Wipe the leather gel match with professional cleanser**



For items use on wooden floor, hard surfaces or carpets, it is recommended to install protective pads under all legs and supports to avoid/prevent from damages/scratches and discoloration