

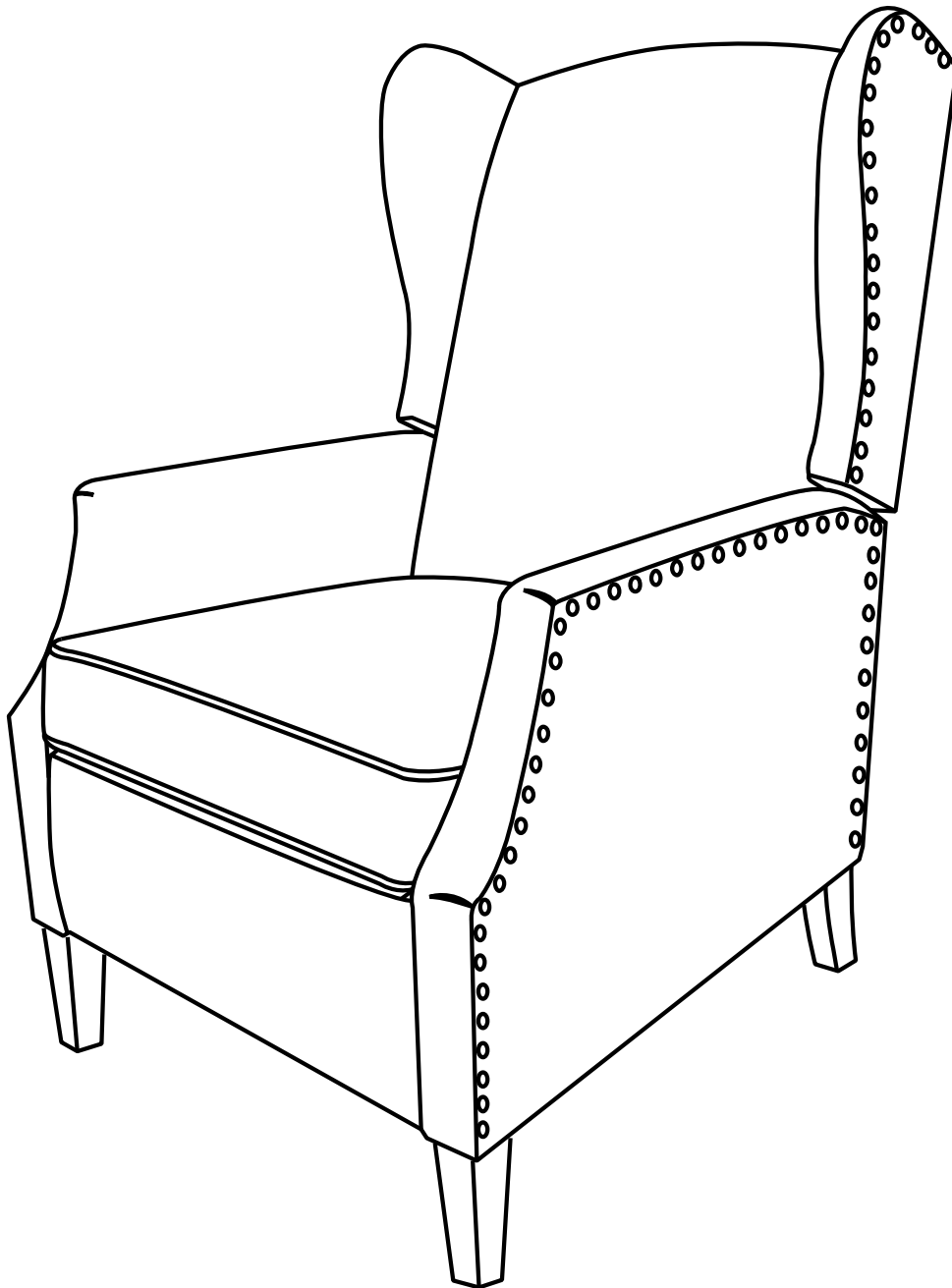





Assembly Instructions

Caution : You must read this before you proceed

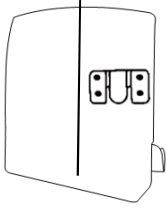

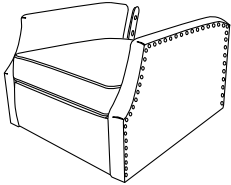

Recliner Chair



Parts List

Label	Picture	Description	QTY
A		Chair Backrest	1
B1		Right Wing	1
B2		Left Wing	1
C		Chair Base	1
D		Front Leg	2
E1		Right Back Leg	1
E2		Left Back Leg	1

Hardware

Label	Picture	Description	QTY
①		Plastic Washer (M8)	3
②		Flat Washer (M6)	3
③		Bolt(M6*40mm)	3
④		Allen Key (M6)	1

⑤		Bolt(M8*40mm)	7
⑥		Allen Key (M8)	1
⑦		Flat Washer (M8)	7
⑧		Spring Washer (M8)	7

Assembly Preparation

Before Beginning Assembly :

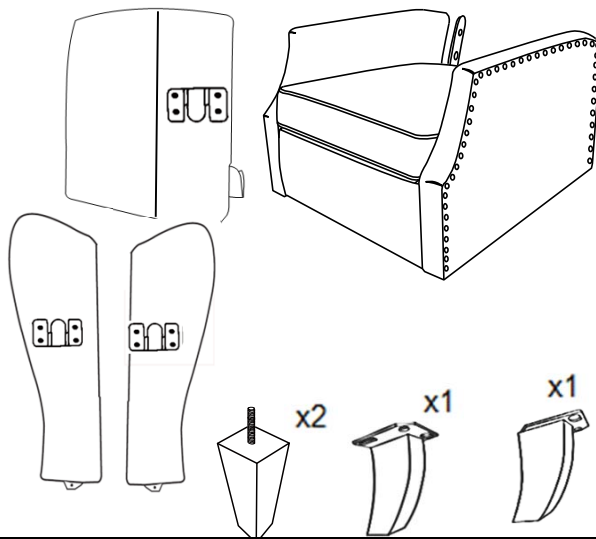

M6

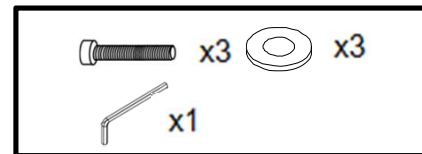

M8

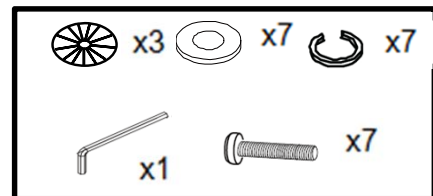

• Read instructions, cover to cover-



• Have 2 adults on hand for assembly-



• Do not assemble on flooring or carpet-



• Assemble on a clean non-marring surface (packing foam)-



• Save all packaging until finished-

Assembly Steps

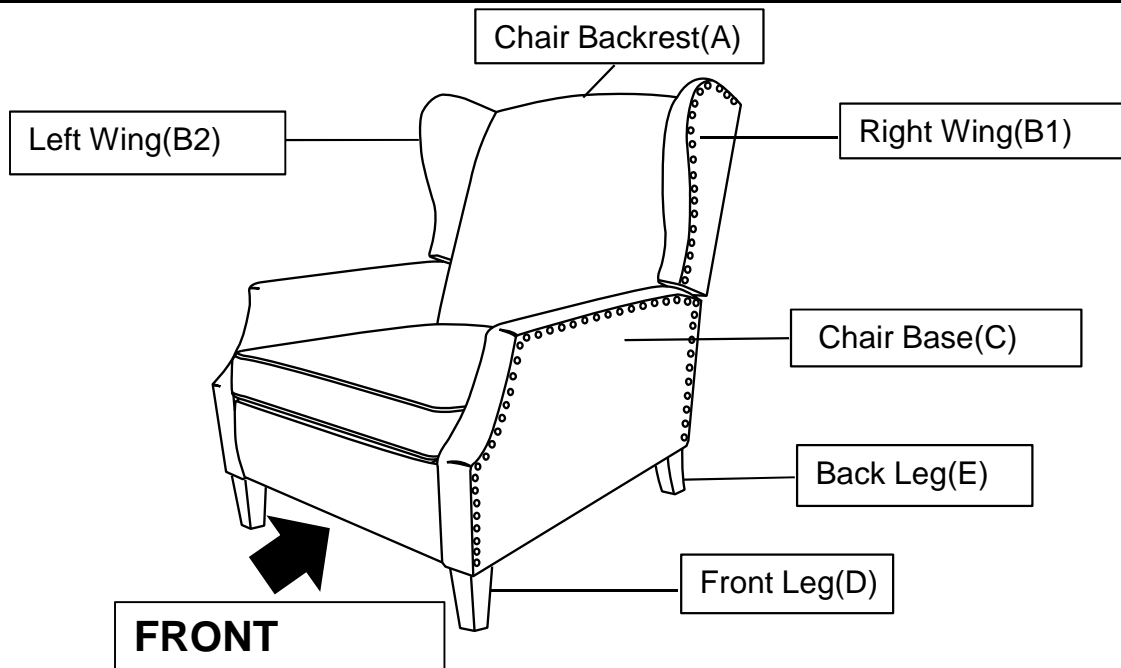

This Recliner Chair has multiple parts and may require up to 30 minutes to assemble. To give you an overview of the Recliner Chair parts, the above picture is to help you put the various parts into perspective. Please read through the instructions below to familiarise yourself with the parts and steps before assembly.

Step 1

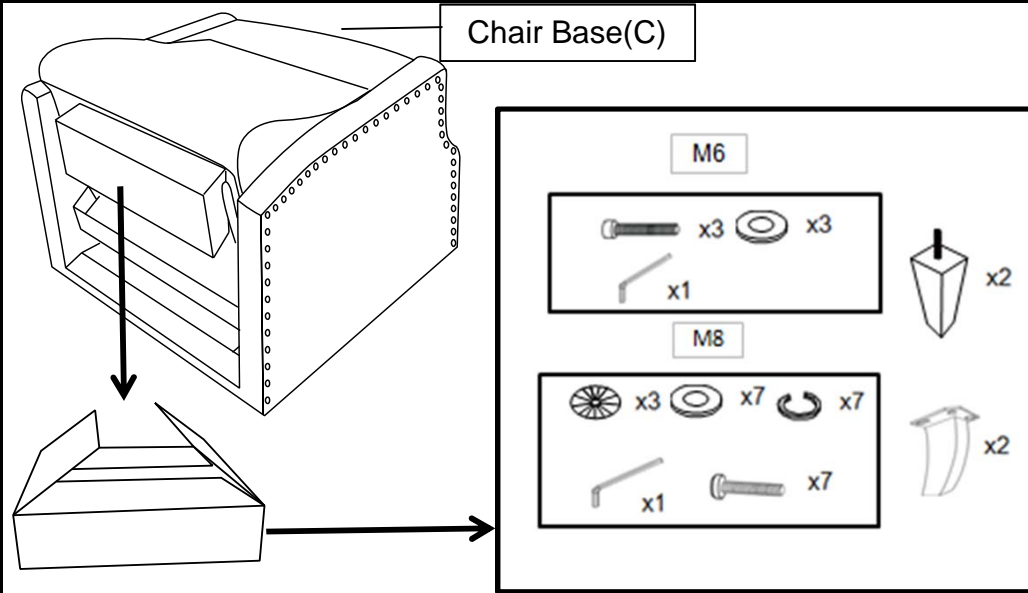

Place the Chair Base(C) on a clean non-marring surface.
Lay Chair Backrest(A) and inner box aside.
Open the inner box and take out the Four Legs and Hardwares.

Step 2

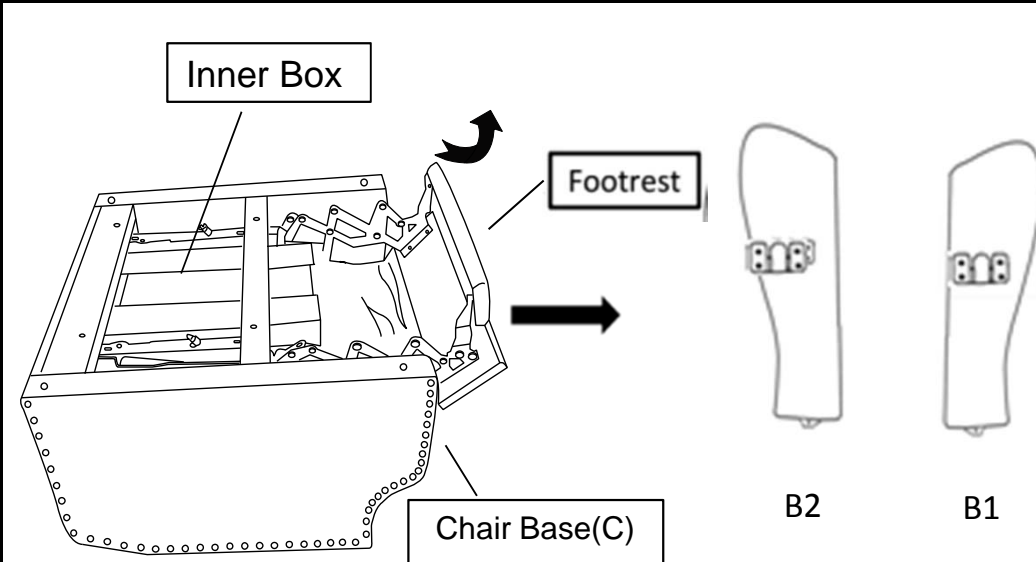

Turn the Chair Base(C) upside down on a clean, non-marring surface.
Extend the Footrest to Open.
Carefully take out Inner Box stowed as shown above.
Open it, and You will find Wings(B1)&(B2).
Stow the Footrest to Original Position.

Step 3

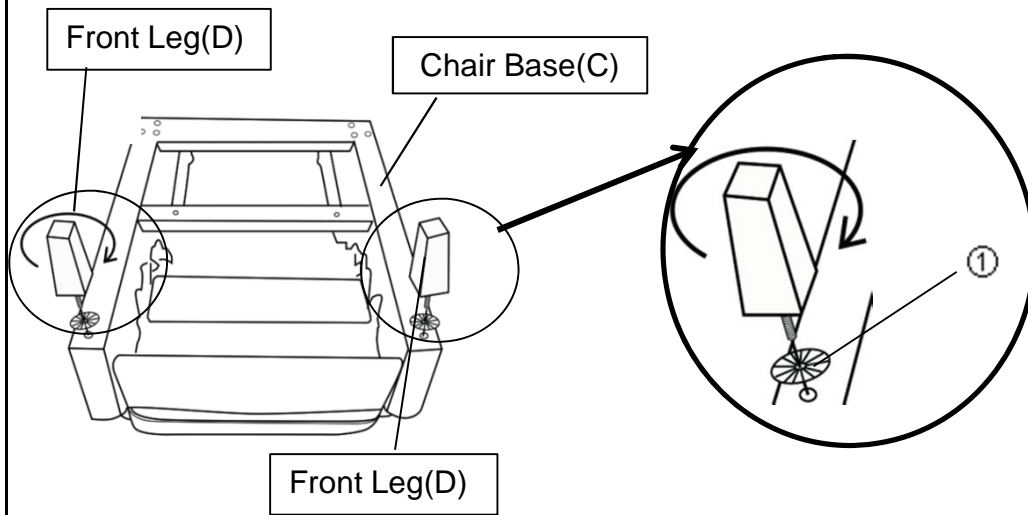

Keep the Chair Base(C) in the same position, first .install the Front Leg(D) at the bottom of the Chair by placing one Plastic Washer① on the threaded stem,Then insert threaded stem into the threaded mounting position at the corner of the chair.

Tighten by turning the Leg Clockwise,DO NOT OVER TIGHT

Repeat the same step to install the remaining another Front Legs(D). Take care of the shape of the Legs and ensure they are in the correct position.

Note:The use of the Gaskets are OPTIONAL and are especially useful to help alleviate slight wobbleness.Some legs may need more than one gasket whilst some legs may not need any.

Step 4

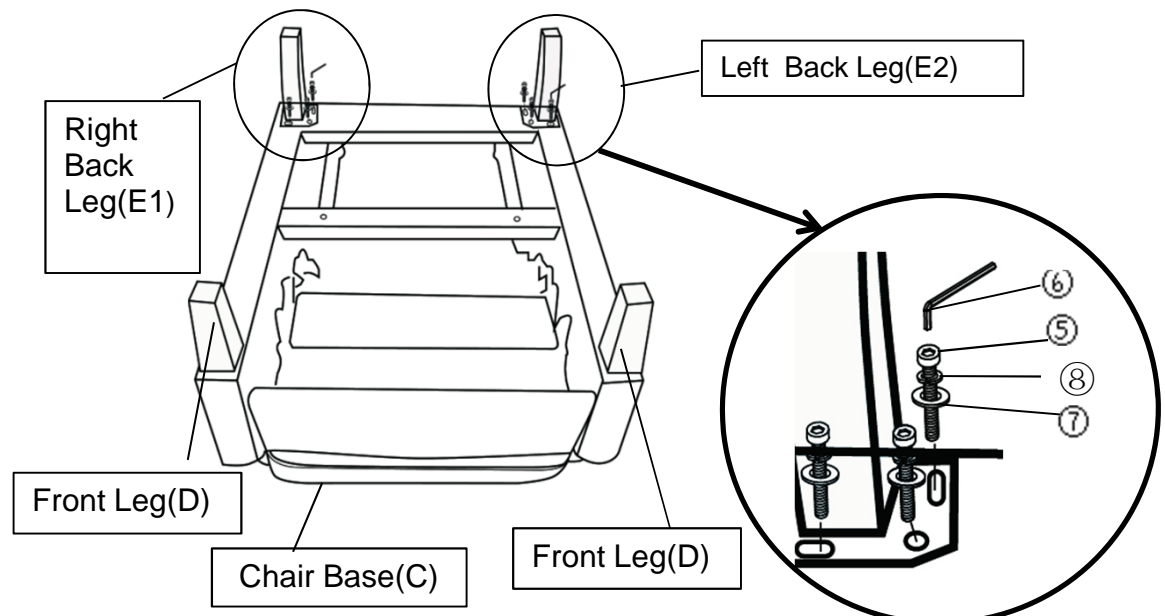

Position the Chair Base(C) on its back, as shown.

Attach the Right Black Leg(E1) to Chair Base(C) using Bolt (⑤),Washer (⑦)and Spring Washer(⑧) with Allen Key(⑥).

Repeat the same steps to install the remaining Left Black Leg(E2),as shown above.

Step 5

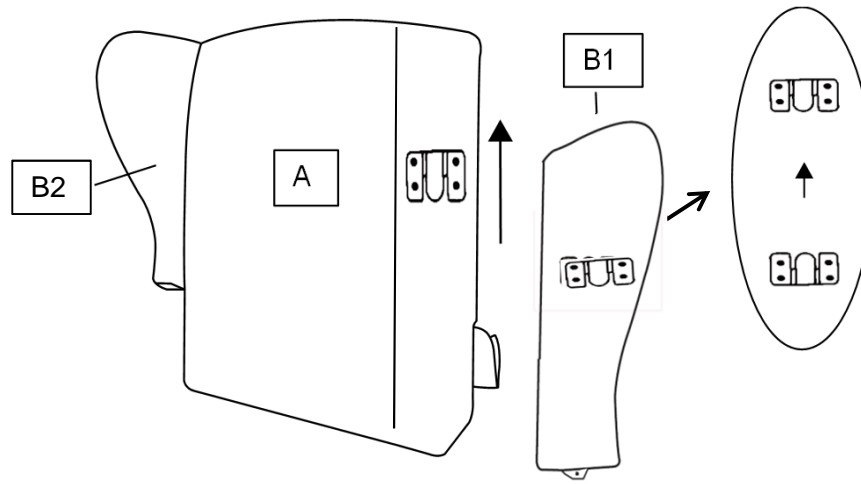

Position the Chair Backrest(A) on it's right side.
Align the mounting positions of the Right Wing(B1) to the right side of Chair Backrest(A) and Repeat the same step to install the Left Wing(B2) to the left side of Chair Backrest(A) as shown above.

Step 6

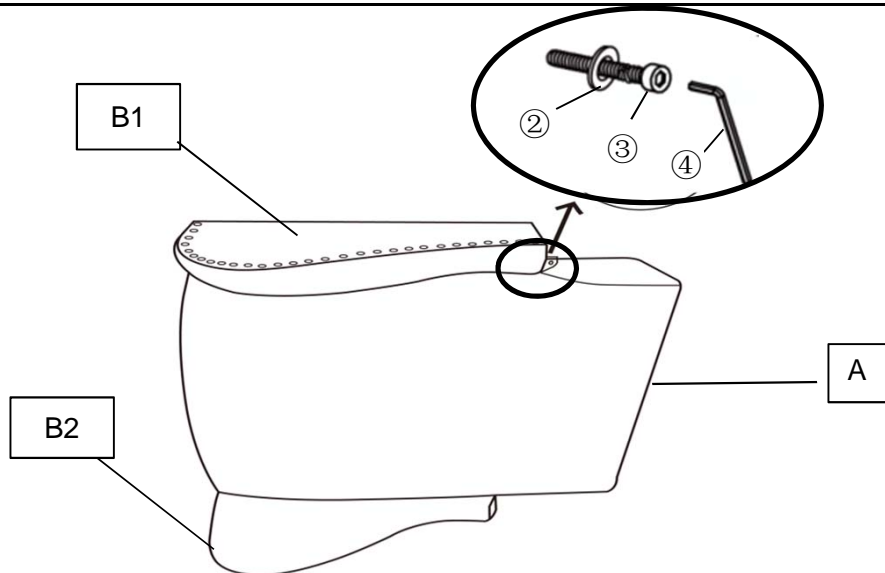

Attach Left Wing(B2) and Right Wing(B1)to the Chair Backrest(A) using Bolts(③) and Flat Washer(②) with Allen Key(④).
Fully tighten it until secure.

Step 7

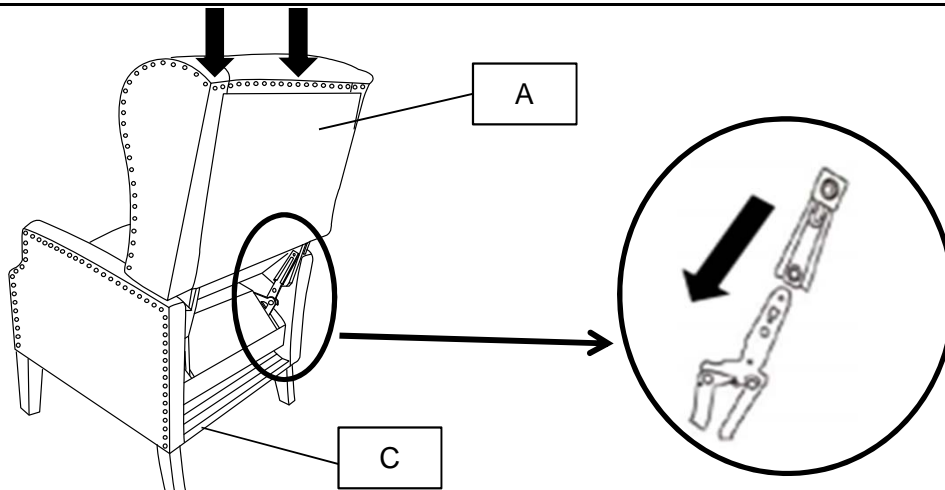

With assistance from your adult partner, hold up the fully assembled backrest with Wings, stand behind the chair. Insert the small metal arms on the sides of the Chair Backrest(A) into the prefabricated slide lock gadget on the Chair Base(C) as shown above. Firmly but gently, push the Chair Backrest(A) downwards until the Backrest is fully slotted and locked into position.

Step 8

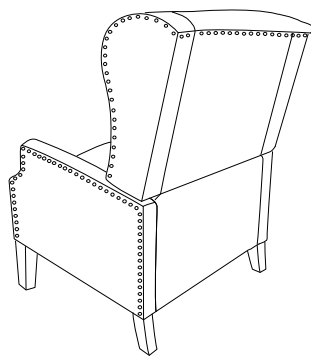

Smooth down the fabric flap on the Chair Backrest. Run your hands down both sides of the flap, from top to bottom, allowing the velcro tape to adhere to the flap under the seat of the chair.

Step 9

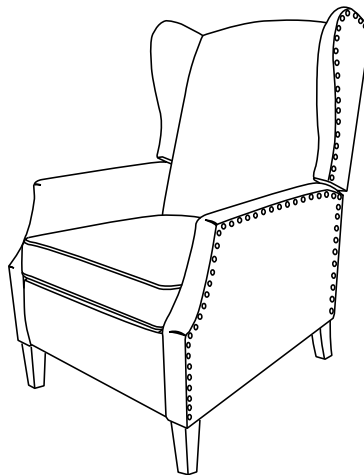

Make sure parts are connected and securely locked into position. Your Chair is ready for use.

Step 10

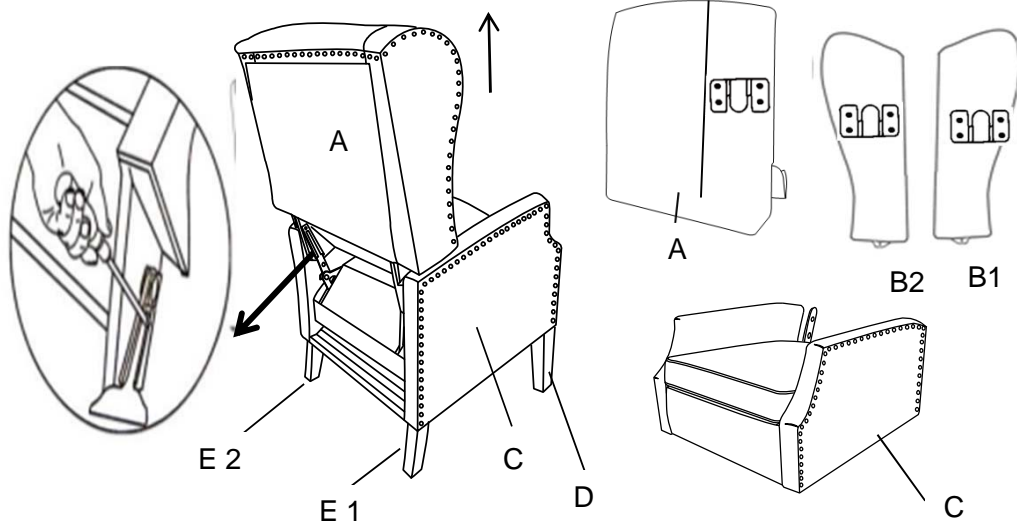

Disassembly Note: Open the flap on the Chair Backrest(A), use a screwdriver (Don't use fingers) pressing outward on the metal ear on the preattached Metal Bracket on one side of the Chair Base(C), with assistance of your adult partner to keep the Chair Base(C) in place, pull out the Chair Backrest(A) upward at the same time, repeat the same step for another side. Then the Chair Backrest(A) can be taken out.

User Instructions.

Recliner Chair

Please read the Instruction Manual below carefully before use.

This is a Recliner Chair. At anytime in a reclined seat position or in the upright position. You may enjoy the rocking motion by using your body weight in a back-front rocking motion.

Supervise children, when in use of this Recliner.

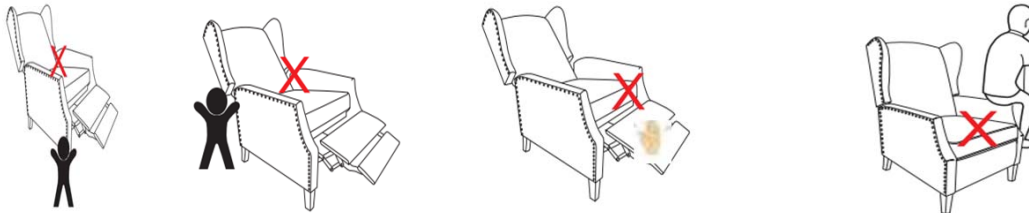

Do not let children stand in front of or behind the Push Back Chair when opening or closing the footrest. Do not put your hands inside the Footrest when opening or closing the footrest. Do not sit any armrest of this Push Back Chair.

To get into a reclined posture - To Recline backrest

Sit into the seat.

Place your feet apart .

Place your left and right arm onto the armrest.

Synchronise a backward push with your arms.

Use your body weight and push backwards into the seat into a fully reclined position.



To get out of chair - move Seatback into Upright Position







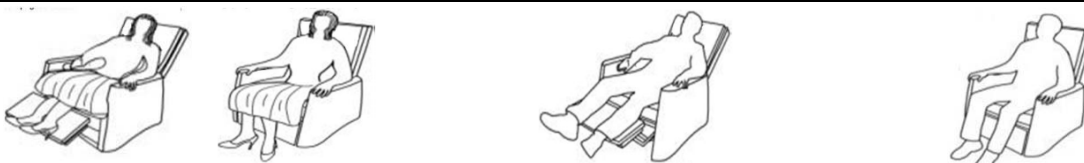













Tilt your body weight slightly forward and upwards.

The seat back will come up to an upright position.

Where necessary, use either your arms help lift- push yourself out of the seat.



Care & Maintenance

-   ● Do not put hot items directly on furniture surface
 -   ● Do not clean furniture with harsh cleansers or polish.
 -   ● Do not place furniture under direct sunlight.
 -   ● Do not place furniture near heating or cooling vents.
 -   ● Do not write on furniture without a padded barrier to protect the surface.
 -   ● Do not place furniture outside . For indoor use only .
 -   ● Not for commercial use. For residential use only .
 -   ● Stains may be removed with mild soap solution and damp cloth.
 -   ● Children should not climb or jump on the furniture.
-
-   ● Dust and pick-up spills using a clean, non-colored, lint-free cloth .

Questions & Answers about Proposition 65

• What is Proposition 65?

Proposition 65 requires businesses to provide warnings to Californians about significant exposures to chemicals that cause cancer, birth defects or other reproductive harm. These chemicals can be in the products that Californians purchase, in their homes or workplaces, or that are released into the environment. By requiring that this information be provided, Proposition 65 enables Californians to make informed decisions about their exposures to these chemicals.

Proposition 65 also prohibits California businesses from knowingly discharging significant amounts of listed chemicals into sources of drinking water.

Proposition 65 requires California to publish a list of chemicals known to cause cancer, birth defects or other reproductive harm. This list, which must be updated at least once a year, has grown to include approximately 900 chemicals since it was first published in 1987.

• What types of chemicals are on the Proposition 65 list?

The list contains a wide range of naturally occurring and synthetic chemicals that include additives or ingredients in pesticides, common household products, food, drugs, dyes, or solvents. Listed chemicals may also be used in manufacturing and construction, or they may be byproducts of chemical processes, such as motor vehicle exhaust.

• What does a warning mean?

If a warning is placed on a product label or posted or distributed at a workplace, a business, or in rental housing, the business issuing the warning is aware or believes that it is exposing individuals to one or more listed chemicals.

By law, a warning must be given for listed chemicals unless the exposure is low enough to pose no significant risk of cancer or is significantly below levels observed to cause birth defects or other reproductive harm.

• Where can I get more information on Proposition 65?

If you have specific questions on the administration or implementation of Proposition 65, you can contact OEHHA's Proposition 65 program at P65.Questions@oehha.ca.gov, or by phone at (916) 445-6900.