

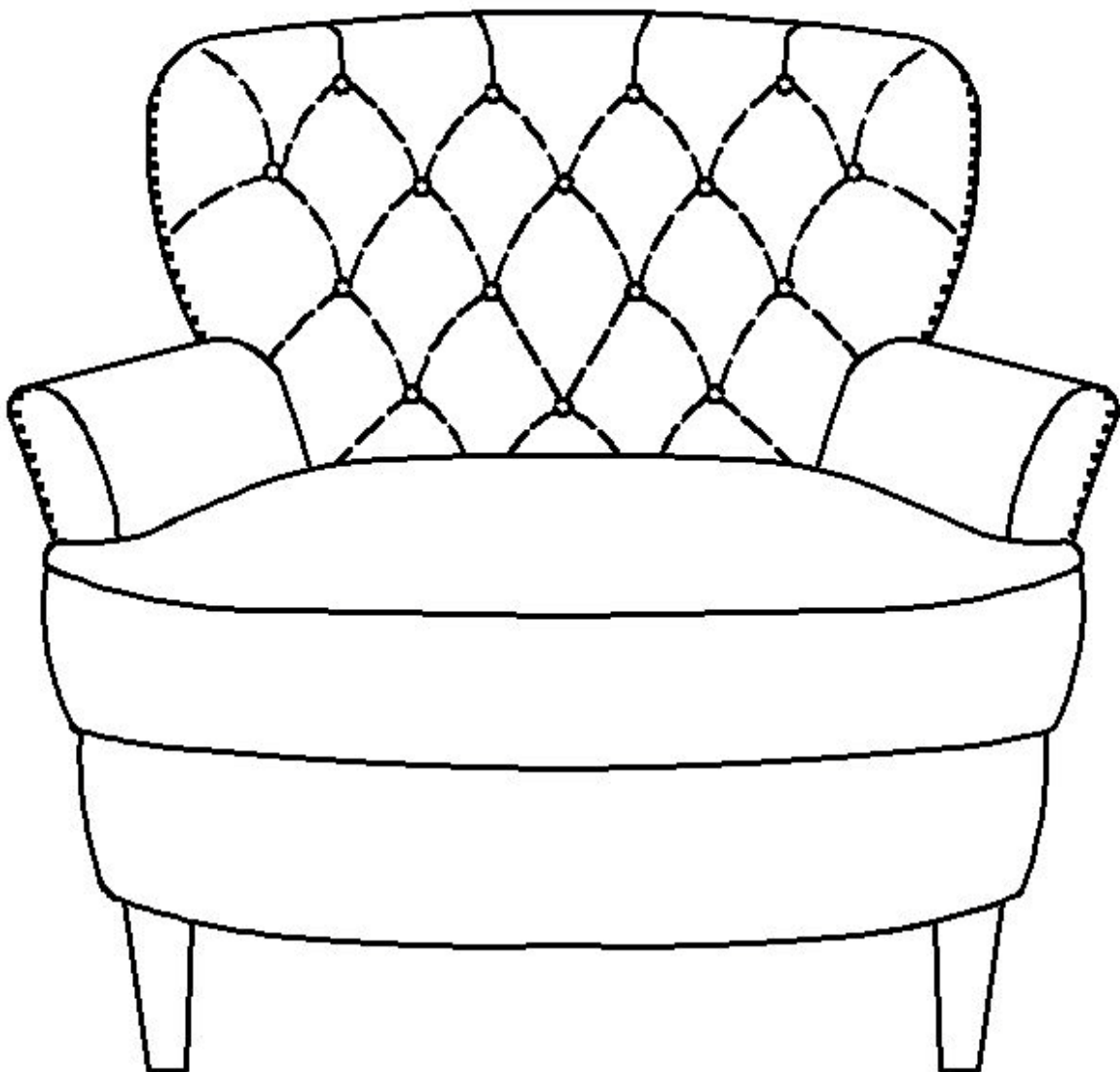



Assembly Instructions

Caution : You must read this before you proceed.



Club Chair



Parts List

Label	Picture	Description	QTY
A		Chair	1
B		Front Wooden Legs	2
C		Back Wooden Legs	2

Hardware

Label	Picture	Description	QTY
①		Gasket	7
②		Silicon Gasket	2

Assembly Preparation

Before Beginning Assembly:

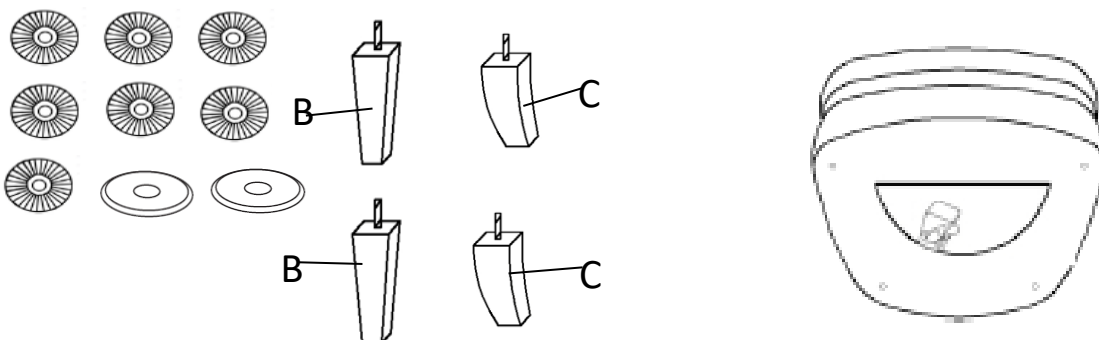



- Read instructions, cover to cover-



- Have 2 adults on hand for assembly-



- Do not assemble on flooring or carpet-



- Assemble on a clean non-marring surface (packing foam)-



- Save all packaging until finished-

Assembly Steps

Overview

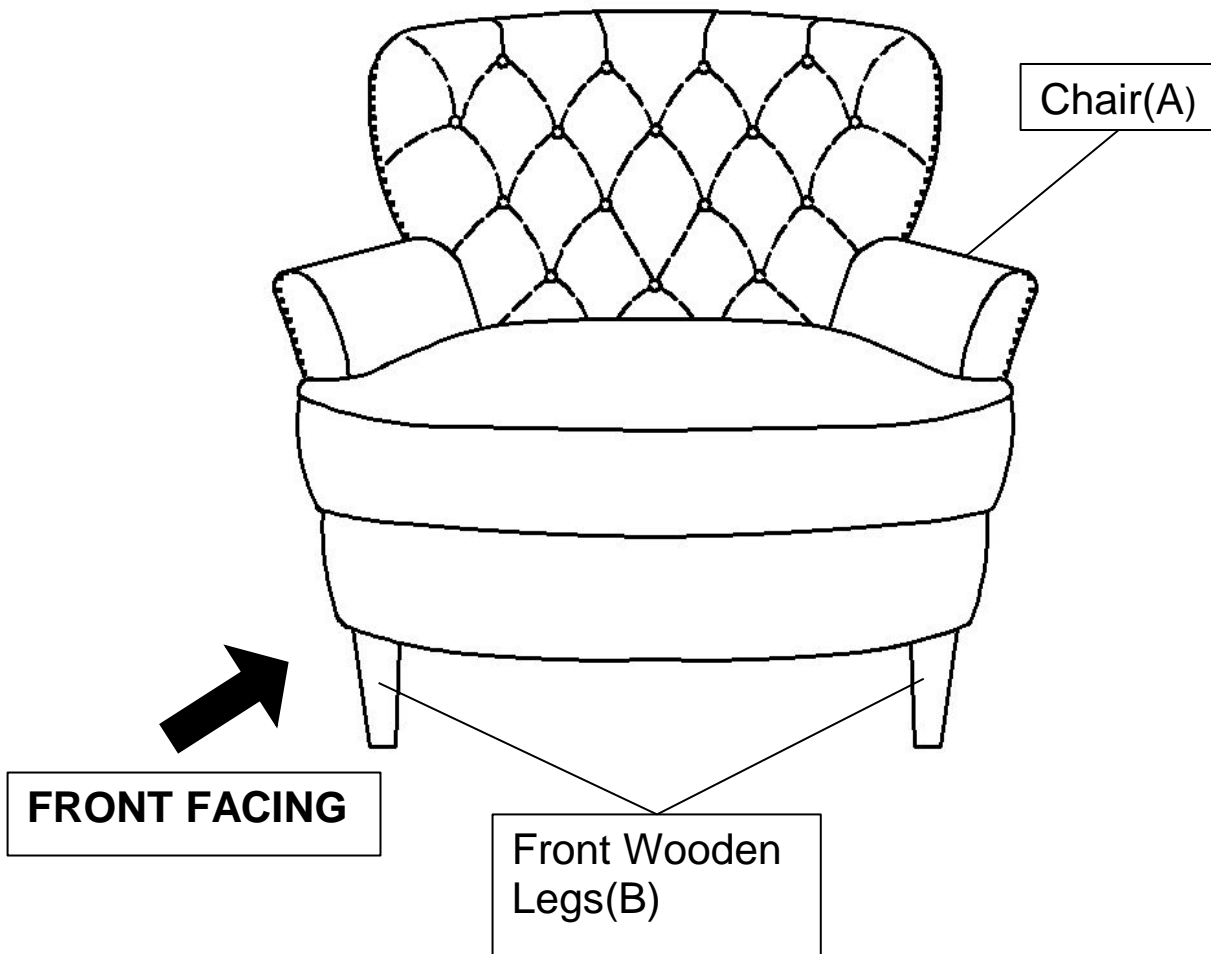

This Club Chair has multiple parts and may require up to 30 minutes to assemble. To give you an overview, the above picture is to help you put the various parts into perspective. Please read through the instructions below to familiarise yourself with the parts and steps before assembly.

Step 1



Position the Chair(A) on its back, as shown.
DO NOT place on surface that can scratch or damage upholstery.
Unzip to open and remove the 4 wooden legs.
Close pouch before assembling.

Step 2

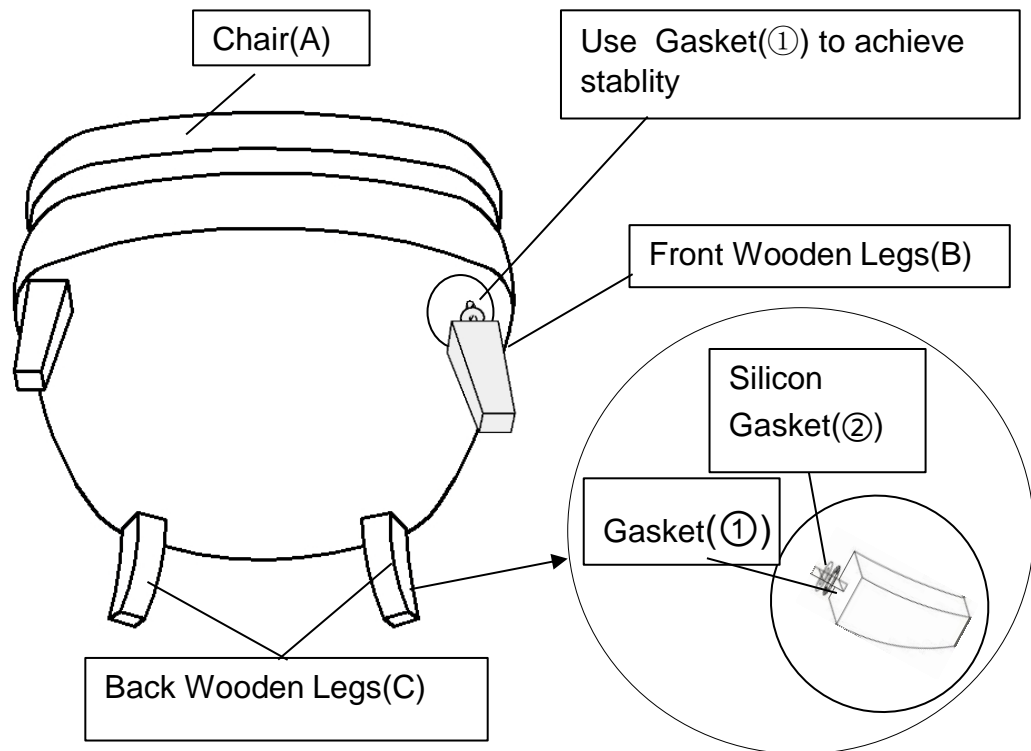

Install the first Front Leg(B) into the Chair (A) by placing one Gasket(①) onto the threaded stem.

Insert the threaded stem of the Front Leg(B) into one of the front mounting positions of the Chair(A), then tighten by turning the Leg clockwise until it is completely secure.

Repeat this process with the remaining Front Leg(B).

Install the Back Leg(C) into the Chair (A) by placing one Gasket(①)and one Silicon Gasket (②) onto the threaded stem. Insert the threaded stem of the Back Leg(C) into one of the back mounting positions of the Chair(A), then tighten by turning the Leg clockwise until it is completely secure.

Repeat this process with the remaining Back Leg(C).

Note: The use of the Gaskets are OPTIONAL and are especially useful to help alleviate slight wobbles. Some Legs may need more than one whilst some Legs may not need any.

Step 3

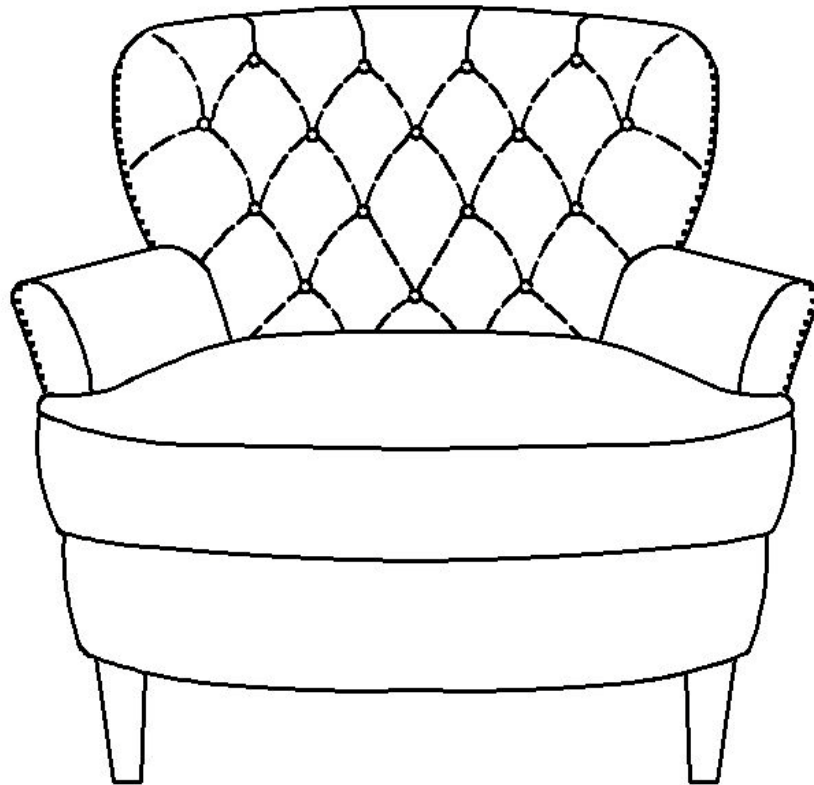

Your Club Chair is ready for use.

This Club Chair can only be used on a flat, level surface.

Care & Maintenance



- Do not put hot items directly on furniture surface



- Do not clean furniture with harsh cleansers or polish.



- Do not place furniture under direct sunlight.



- Do not place furniture near heating or cooling vents.



- Do not write on furniture without a padded barrier to protect the surface.



- Do not place furniture outside . For indoor use only .



- Not for commercial use. For residential use only .



- Stains may be removed with mild soap solution and damp cloth.



- Children should not climb or jump on the furniture.



- Dust and pick-up spills using a clean, non-colored, lint-free cloth .



Assembly Instructions

Caution : You must read this before you proceed.

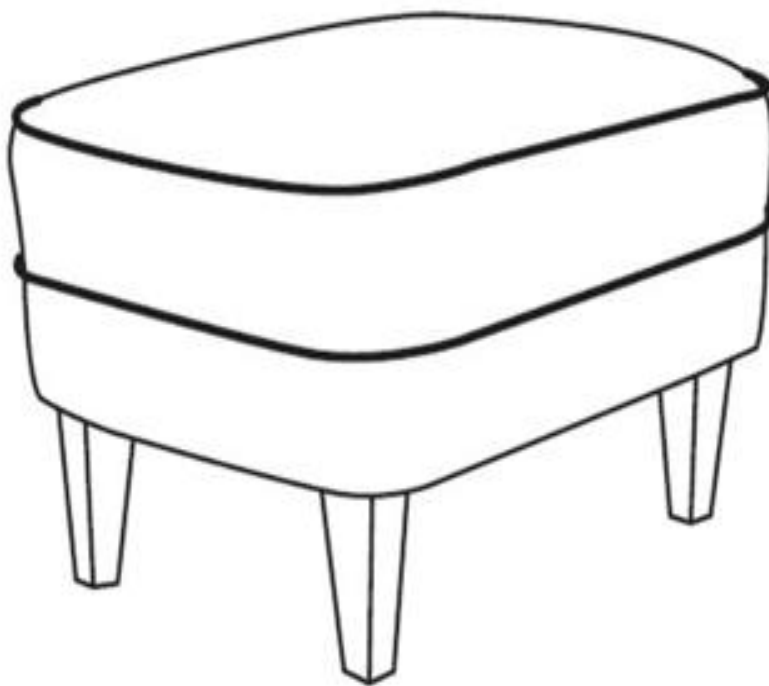
Ottoman

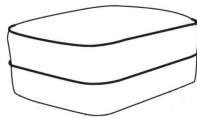

Parts List

Label	Picture	Description	QTY
A		Ottoman	1
B		Wooden Legs	4

Hardware

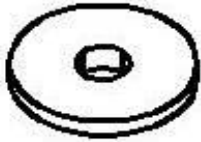
Label	Picture	Description	QTY
①		Washer Rings	7

Assembly Preparation

Before Beginning Assembly:

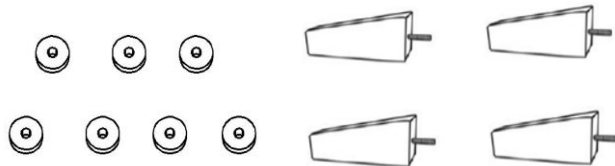
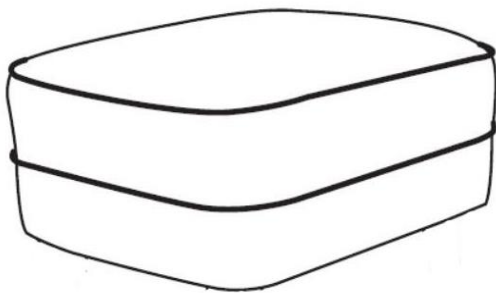

- Read instructions, cover to cover-



- Have 2 adults on hand for assembly-



- Do not assemble on flooring or carpet-



- Assemble on a clean non-marring surface (packing foam)-



- Save all packaging until finished-

Assembly Steps

Overview

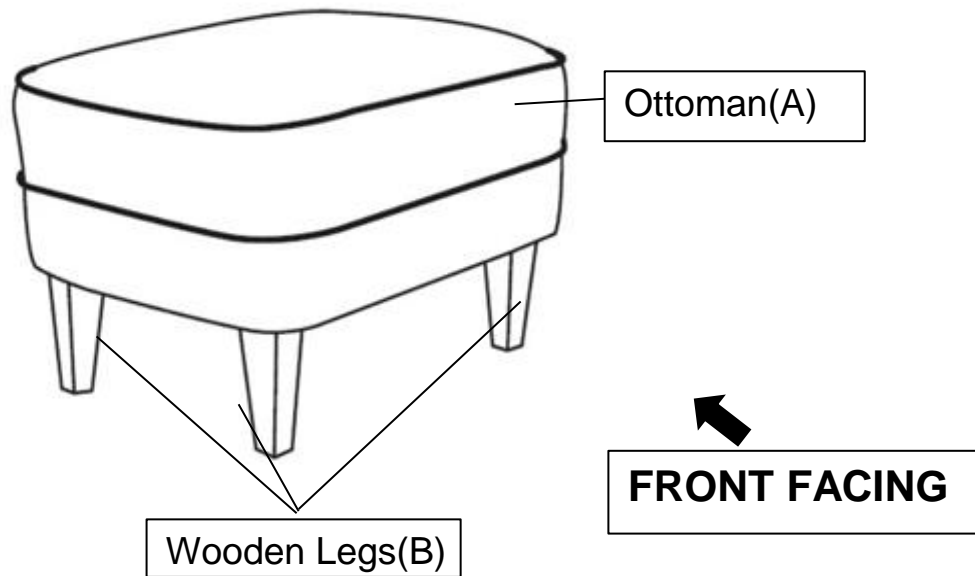

This Ottoman has multiple parts and may require up to 30 minutes to assemble. To give you an overview of the Ottoman parts, the above picture is to help you put the various parts into perspective. Please read through the instructions below to familiarise yourself with the parts and steps before assembly.

Step 1

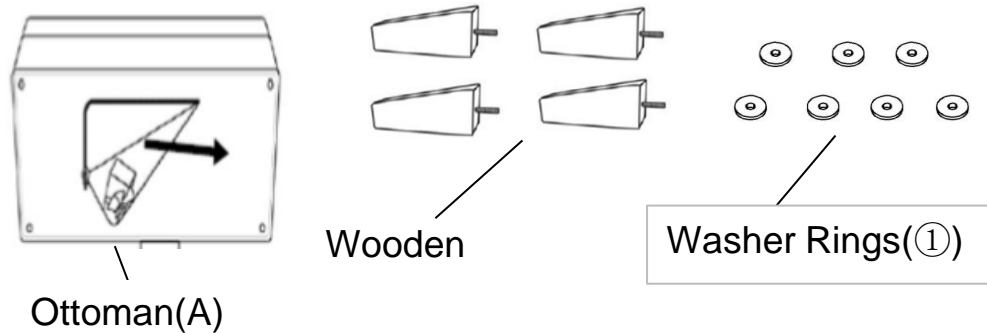

Place the Ottoman(A) on a clean, non-marring surface with the bottom facing you, as shown in picture above. Unzip to open and remove the 4 Wooden Legs(B). Close pouch before assembling.

Step 2

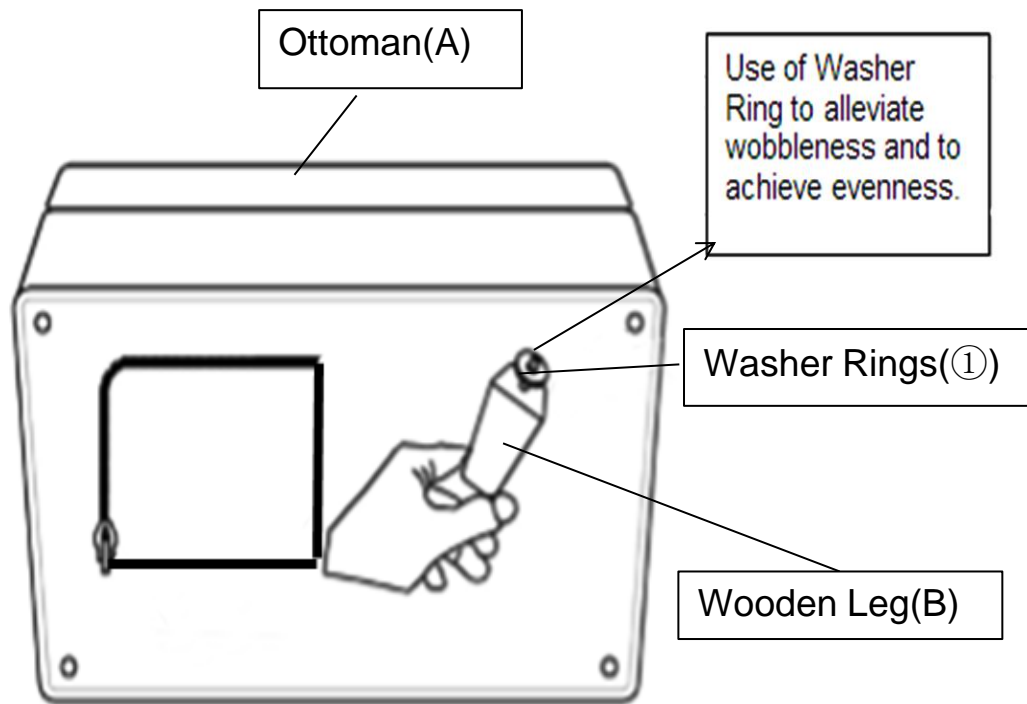

Place the Ottoman(A) on its side, as shown above.

Install the first Leg into the bottom of the Ottoman by placing 1 piece of Washer Ring(1) on the threaded stem.

The use of Washer Rings(1) improves tightness and security of leg after assembly.

Tighten by turning the leg clockwise.

Repeat the same step to install the three remaining legs.

Note: The use of Washer Rings are OPTIONAL and is especially useful to help alleviate slight wobbleness.

Some Legs may need more than one whilst some legs do not need any.

Step3

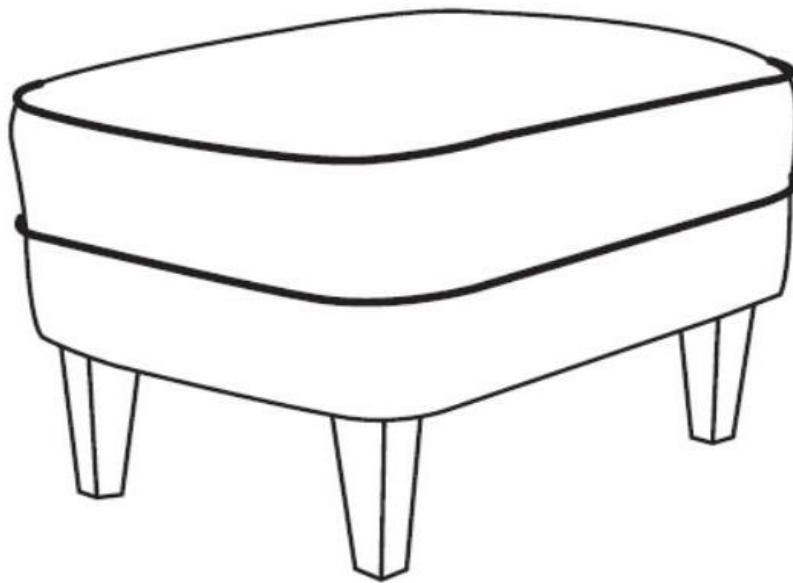











Stand the Ottoman up.

Your Ottoman is ready for use.

Caution: This Ottoman can only be used on a flat, level surface.

Care & Maintenance

-  Do not put hot items directly on furniture surface
 -  Do not clean furniture with harsh cleansers or polish.
 -  Do not place furniture under direct sunlight.
 -  Do not place furniture near heating or cooling vents.
 -  Do not write on furniture without a padded barrier to protect the surface.
 -  Do not place furniture outside . For indoor use only .
 -  Not for commercial use. For residential use only .
 -  Stains may be removed with mild soap solution and damp cloth.
 -  Children should not climb or jump on the furniture.
-
-  Dust and pick-up spills using a clean, non-colored, lint-free cloth .