

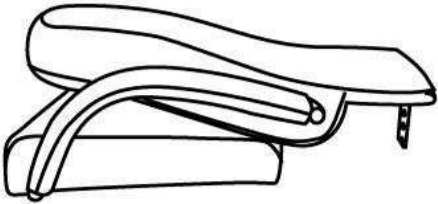

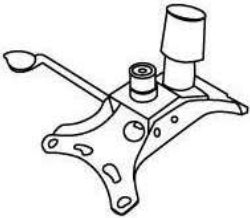

Please unscrew all hardware from cushion before assembly.
Por favor de destornillar todos los tornillos del cojín antes de ensamblar la silla.

MODEL: B8376

(1)x1		
 <p>Back & Seat W/ ARMS</p>		
(2)x1	(3)x1	(4)x1
 <p>Mechanism</p>	 <p>Gas Lift W/ Cover</p>	 <p>5-Star Base</p>
(A)*4PCS	 <p>M8*22 MECHANISM SCREW</p>	
(B)*4PCS	 <p>M6*30 BACK BAR SCREWS</p>	
(C)*4PCS	 <p>ARM CAP</p>	
(D)*1PC	 <p>ALLEN KEY</p>	

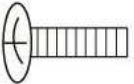
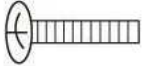

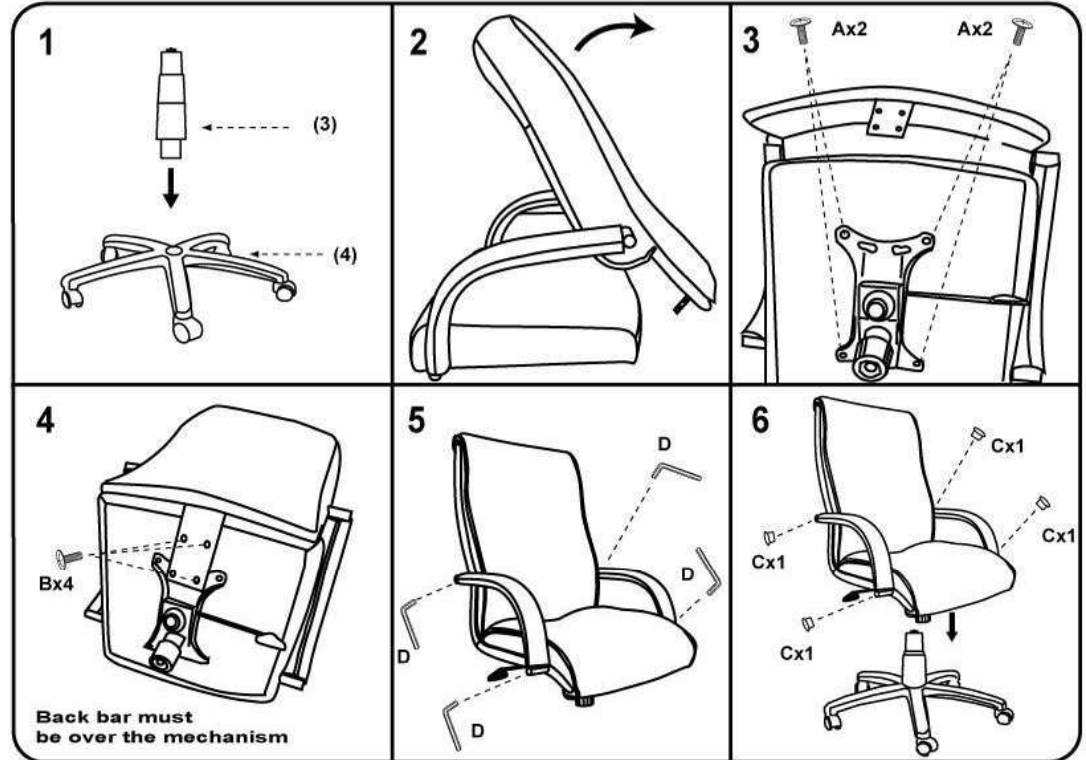
Note: Please tighten all arm screws using allen key before step 6

Insert and loosely tighten all screws. When assembly is completed, fully tighten all screws before using. This chair is only intended for sitting. Any other use will void the warranty.

