

MODEL: BTO48

(1)x4

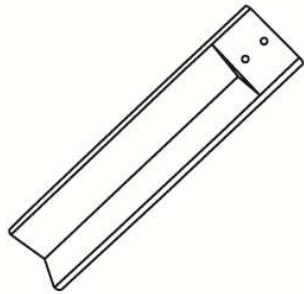

Table Leg

(2)x1

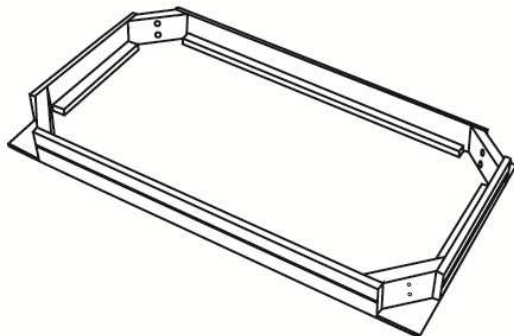
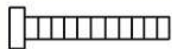
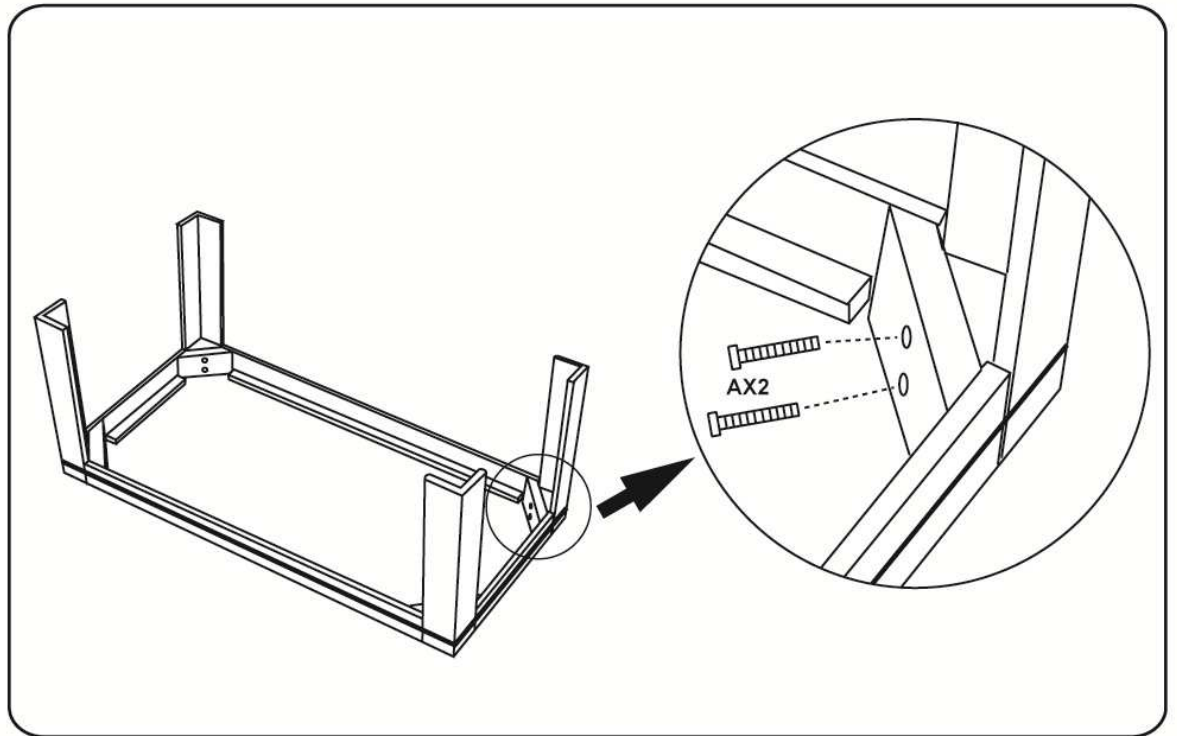

Table Top

(A)x8



M6X50



1. Lay table top upside down on a solid protected surface;
 2. Match up the number marked on table top & table leg before inserting the screws;
- * Max.weight capacity:155 Lbs.

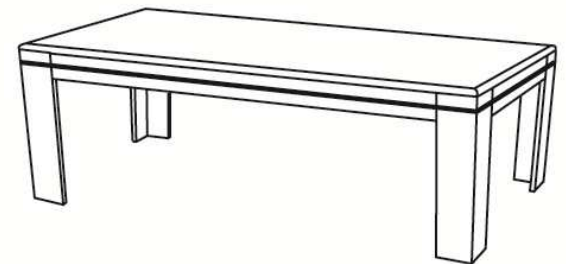

Customer Service Hotline: 1-800-593-1888
For further assembly instructions,
please visit our website at www.bosschair.com